

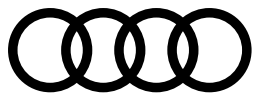

The 2019 Audi A8 Infotainment and Audi Connect Systems

eSelf-Study Program 990293



Audi of America, LLC
Service Training
Created in the U.S.A.
Created 06/2018

Course Number 990293

©2018 Audi of America, LLC

All rights reserved. Information contained in this manual is based on the latest information available at the time of printing and is subject to the copyright and other intellectual property rights of Audi of America, LLC., its affiliated companies and its licensors. All rights are reserved to make changes at any time without notice. No part of this document may be reproduced, stored in a retrieval system, or transmitted in any form or by any means, electronic, mechanical, photocopying, recording or otherwise, nor may these materials be modified or reposted to other sites without the prior expressed written permission of the publisher. All requests for permission to copy and redistribute information should be referred to Audi of America, LLC.

Always check Technical Bulletins and the latest electronic service repair literature for information that may supersede any information included in this booklet.

Revision 1: Jun 14, 2018

The eSelf-Study Program (eSSP) teaches a basic understanding of the design and mode of operation of new models, new automotive components or new technologies.

It is not a repair manual! Figures are given for explanatory purposes only and refer to the data valid at the time of preparation of the SSP.

For further information about maintenance and repair work, always refer to the current technical literature.



Note



Reference

Modular infotainment matrix generation 2+	2	Rear Seat Entertainment	40
Introduction.....	2	Rear Seat Entertainment.....	40
Design.....	2	Audi connect	41
Operating concept.....	4	Introduction.....	41
MIB2+ High with navigation system.....	9	Using the Audi connect services.....	43
Drives and external connections	11	Audi connect stolen vehicle locator.....	44
USB Distributor R293.....	11	Appendix	46
USB Connection 1 U41.....	11	Glossary.....	46
DVD Changer R161.....	12	eSelf-study programs.....	51
Radio	13	Knowledge assessment	52
Introduction.....	13		
DAB tuner.....	13		
Navigation	14		
Route calculation.....	14		
Connected Points of Interest (POIs).....	14		
New feature in route guidance.....	15		
Navigation information.....	16		
Display and operating units	17		
Introduction.....	17		
Technical features.....	17		
Networking.....	17		
Function.....	18		
Other features.....	18		
Button combinations for service.....	19		
Sound	20		
Introduction.....	20		
Bang & Olufsen Premium Sound System with 3D sound (9VS).....	21		
Bang & Olufsen Advanced Sound System with 3D sound (8RF).....	23		
Antennas	25		
Rear window.....	25		
Bluetooth.....	27		
Wi-Fi.....	27		
Roof Antenna.....	28		
Antenna filter for GPS R110.....	28		
Mobile phone antennas.....	29		
Audi phone box	31		
General information.....	31		
Mobile Device Charger 1 J1146.....	32		
Mobile Device Charger 2 J1147.....	32		
Diagnosis.....	33		
Function displays.....	33		
Rear Seat Remote	34		
Design.....	34		
Function.....	35		
Diagnosis.....	36		
Networking	37		
Topology.....	37		
Image transfer.....	39		

The MIB2+ generation ↗ of the modular infotainment matrix of the 2019 Audi A8 is a fundamental revolution for Audi models regarding information and entertainment in a vehicle. It represents a new milestone for the entire Audi product range.

The 2019 A8 comes standard with MMI Navigation Plus. The performance of the system, the introduction of new functions and hardware, the innovative operating concept and the further integration of the Internet in both convenience and safety/security-related applications make travelling in the Audi A8 an exceptional experience. Due to the modular structure of Information Electronics Control Module 1 J794, this experience will continue to take on new dimensions.



666_002

Modular infotainment matrix generation 2+

Introduction

Increasing requirements in the area of operation, communication and display make ever more powerful devices necessary. To meet these requirements, Information Electronics Control Module 1 has been significantly modified with the introduction of MIB2+.

Compared to the previous MIB2 structure, the following modifications have been made:

- › Computing power increased by a factor of 1.5.
- › Memory capacity increased by a factor of 2.
- › Graphics performance for the displays increased by a factor of 2.

Design

The standard *SD* card reader ↗ and the optional *SIM* card reader are no longer in J794 but have been moved to a shared module with the *USB* connections ↗. This module is referred to as the Audi music interface; the designation is *USB Distributor R293*.

J794 also now no longer has an optical drive (*CD* ↗ or *DVD* ↗). An optical drive is now only available as a separate control unit (optional equipment).

J794 has two modules which cannot be separated in service: the *RCC* module and the *MMX* module. Components of the *RCC* module are not subject to rapid technological changes whereas the components of the *MMX* will need to be modified more quickly for future device generations.

Components in the *RCC* include:

- › Radio tuner
- › Sound amplifiers
- › *CAN* and *MOST* interface
- › Diagnostic software
- › Gyroscope

Components in the *MMX* include:

- › Main processor
- › Graphics chip
- › Bluetooth module
- › *Wi-Fi* module ↗ (antenna is located separately)
- › *LTE* mobile phone module ↗ (telephone and data up to 300 Mbit/s)
- › Navigation



666_005

MMI Navigation plus (I8T + 7UG)



662_187

10.1" touchscreen with 1540 x 720 pixel resolution

8.6" touchscreen with 1280 x 660 pixel resolution

Audi virtual cockpit (9S8)

3D SSD navigation system (7UG)

AM/FM radio

Audi connected Radio (Internet radio)

Satellite radio for North America (Sirius) (QV3)

Audi music interface with 2 USB ports, 1 SDXC card reader

Bluetooth interface (9ZX)

UMTS/LTE data module (EL3) including Audi connect (IT3)

DVD changer (6G2 - front and rear are optional)

Audi music interface in the rear with 2 USB ports (UF8) Optional

Audi smartphone interface (IU1)

Rear Seat Remote (QW5)

Audi phone box (including wireless charging) (9ZE) Optional

Bang & Olufsen Premium Sound System with 3D sound (9VS) Standard

Bang & Olufsen Advanced Sound System with 3D sound (8RF) Optional

DAB digital radio

Auto SOS & connect vehicle-specific services (IW3)

Integrated Rear Seat Entertainment including 2 Audi tablets (9WF)

Operating concept

Introduction

The introduction of touch displays and the reduction of controls in the center console brings a new operating concept to the 2019 Audi A8.

Using the MMI in the Audi A8 is similar to using a smartphone. The system is based on intuitive, self-explanatory procedures. Typical smartphone movements, such as swiping or moving items, can now be used to operate the MMI.



666_072

Upper display

The upper touch display allows the user access to the main functions and to the corresponding sub-menus. Unlike in previous MMI generations, there is no Audi connect menu in MIB2+. With a small number of exceptions (weather, news, etc.), all connect services are assigned to the corresponding main functions and are therefore not visible on the home screen.

The layout of the function tiles on the home screen can be configured by holding and sliding the tiles. Frequently used functions can be selected using shortcuts on the left edge of the display.

Customers can adjust the assignment and position of the shortcuts according to their personal preferences. The only exception is the home button; this is fixed in the left menu.

Swiping downward from the upper edge opens a selection of four permanently defined shortcuts:

- > Sound settings.
- > MMI settings.
- > Connections.
- > User profiles.

A display at the top right (always visible) includes information on:

- > Bluetooth.
- > User profile.
- > Reception status.
- > Data transfer.



666_073



666_074



666_075



666_076

Lower display

The main purpose of the lower display is to operate the climate control system and activate permanent and personalized shortcuts.

The personalized shortcuts may include telephone contacts, radio stations, navigation destinations and vehicle settings which have been copied from the upper to the lower display for a convenient selection.

Tapping the center button at the top edge of the display allows the user to display and hide the shortcuts. These are selected without the user needing to preselect the main function (for example, navigation destinations, telephone contacts, radio stations, etc.). They are in a row on a toolbar and can be identified quickly and easily by the different tile colors. The user always has the option of changing their layout.

The permanently defined shortcuts, however, are vehicle functions which may be present depending on the vehicle's equipment. These shortcuts are at the top and bottom of the display.

The center button on the lower toolbar can be used to change the assignment of the buttons to its immediate left and right according to personal requirements (see magnified section).



666_077

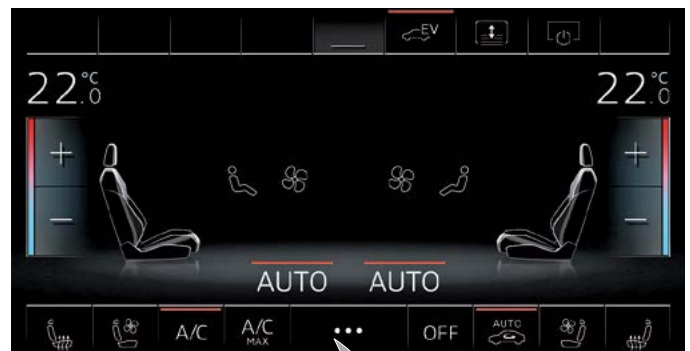

666_078



666_079

It is also possible to enter navigation destinations, addresses, telephone numbers, etc. by hand on the lower display. This has been made much more convenient. The system detection is now more precise and quicker. Unlike in the recent MMI touch system, entire words can now be entered without pauses. The letters do not even need to be written next to each other. The entry can be made in one place.

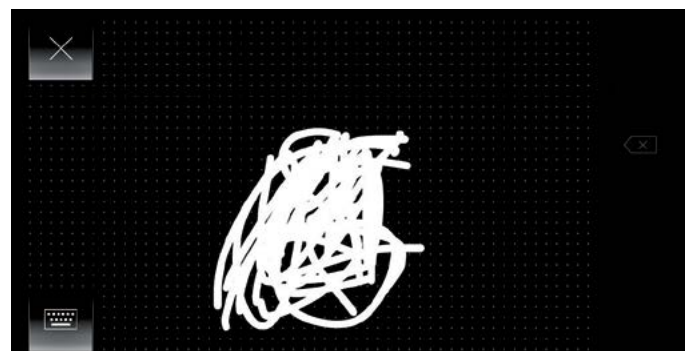

666_080

If a telephone number entered is not clear, the system suggests possible alternatives on the upper display.



666_081

The delete function has been optimized significantly.

It is possible to delete as many characters as desired by swiping left. If the user deletes too many characters by accident, they can be restored by swiping in the other direction.



666_082

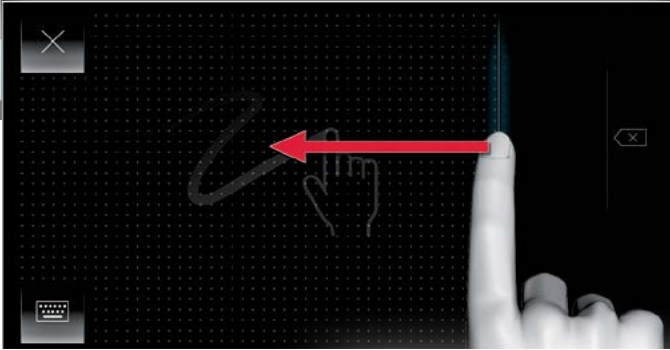

666_083

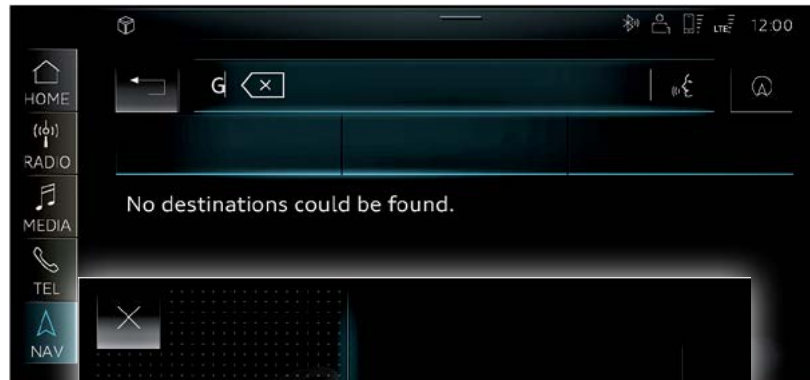

666_084



666_085

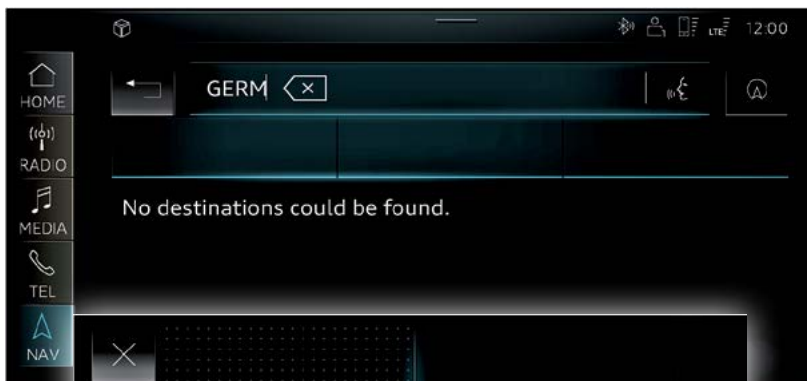

666_086

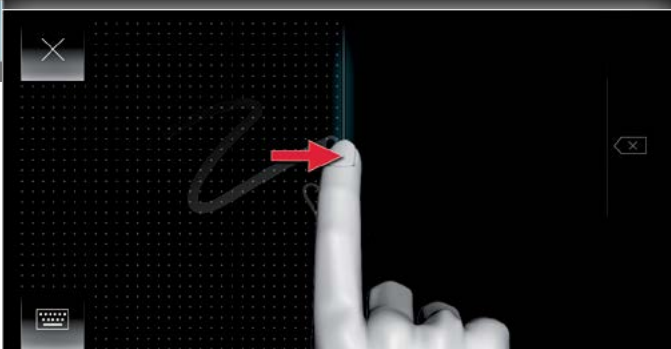

666_087

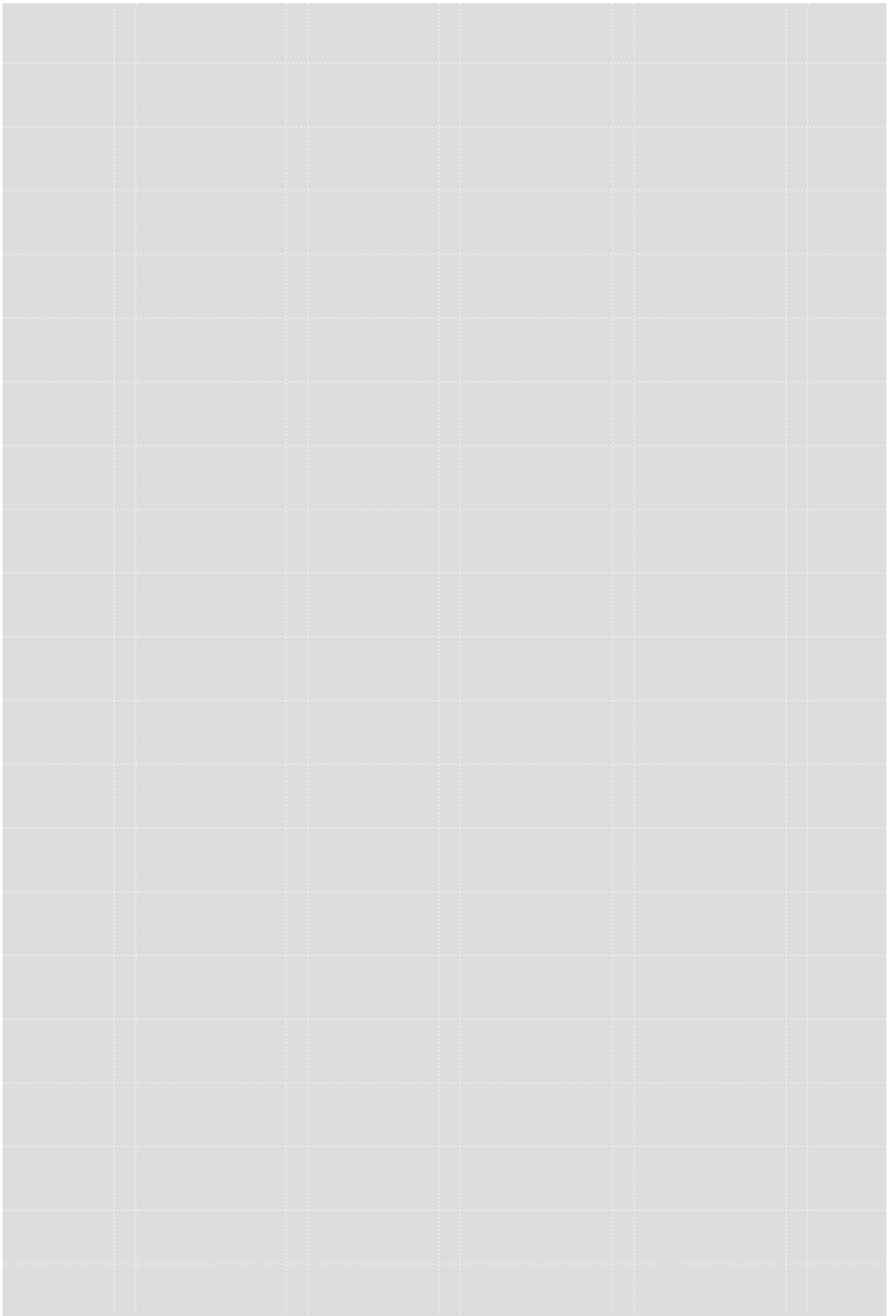

MIB2+ High with navigation system

The MMI navigation plus has the following features as standard:

- > Radio with phase diversity, FM dual tuner (very high frequency) and AM tuner (medium wave) and background tuner.
- > 3D navigation with data on SSD with improved 3D city center models (7UG).
- > LTE-enabled mobile network module, possible data transfer rates of up to 300 Mbit/s (EL3) for:
 - > Audi connect active license (IT3) including Wi-Fi hotspot with a possible data transfer rate of up to 150 Mbit/s.
 - > Navigation with online routing.
- > Internal audio amplifier, 180 W (9VD).
- > Bluetooth interface for HFP, A2DP and MAP (9ZX).
- > Speech dialog system.
- > 1 image output for Audi virtual cockpit.
- > 1 image output for both touch displays (1540 x 720 and 1280 x 660 pixels).
- > Audi music interface with 1 SDXC card reader, 2 USB sockets (UF7) and, depending on market, 1 SIM card reader (EL3).

The following additional equipment can be ordered:

- > Functions integrated in J794:
 - > DAB dual tuner (digital radio) (QV3).
 - > SDARS tuner (North America digital radio) (QV3).
 - > Audi smartphone interface (IU1).
- > Functions in separate control units:
 - > DVD changer (6G0)¹.
 - > Front Audi phone box (9ZE).
 - > Rear Audi phone box (QF7).
 - > Rear Seat Remote (QW5).
 - > 2 Audi tablets (9WF).
 - > Bang & Olufsen Premium Sound System with 3D sound and 660 W (9VS).
 - > Bang & Olufsen Advanced Sound System with 3D sound and 1920 W (8RF).



Main menu on MMI navigation plus

666_009



Connections on Information Electronics Control Module 1 J794



USB Distributor R293

666_047

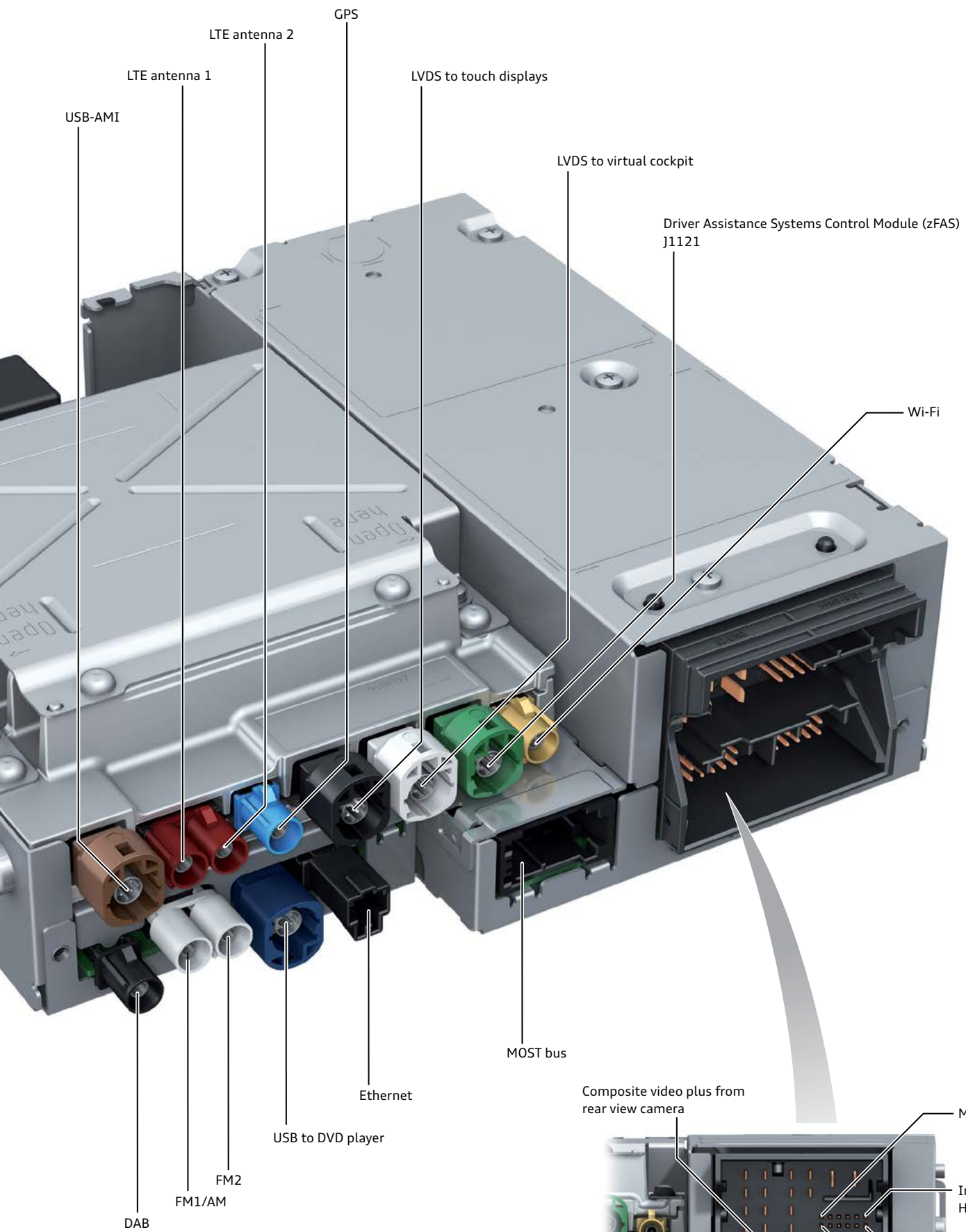

666_010

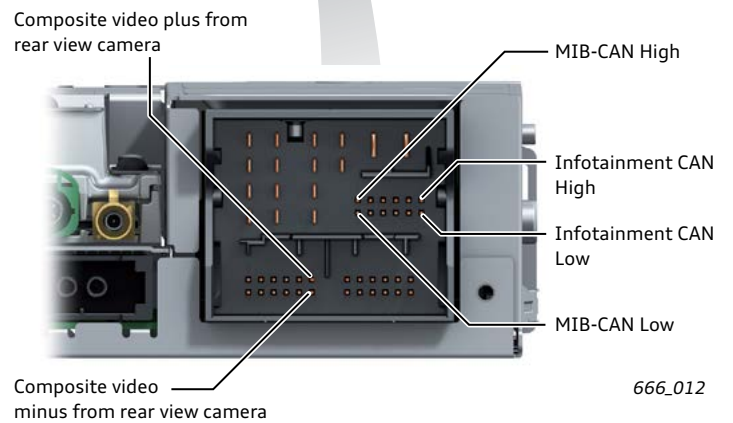

666_012

Drives and external connections

USB Distributor R293

R293 has two USB connections and one SDXC card reader.

R293 is connected to Information Electronics Control Module 1 J794 by a USB interface. All diagnosis functions for R293 are stored in J794 and can be accessed via Address Word 005F using the VAS Scan Tool.

The USB connections support the USB 2.0 standard. Each connection can provide charging current up to 1.6A.

Every 2019 Audi A8 will be equipped with the Audi music interface (AMI). Together with the software in Information Electronics Control Module 1 J794, the system requires USB Distributor R293.



USB Distributor R293

666_047



USB connection to U41

USB connection to J794

666_015

USB Distributor R293 (back)

USB Connection 1 U41

Two USB connections are available optionally in the rear of the Audi A8. They are integrated in USB Connection 1 U41 and are installed with by ordering the “Audi music interface in rear” (UF8).

USB Connection 1 U41 is connected to the USB Distributor R293 via a USB interface. Its signal is sent from R293 to J794. All diagnosis functions for U41 are performed via J794.

The connections support the USB 2.0 standard. Each connection can provide charging current of up to 2.1 A.



USB Connection 1 U41

666_016

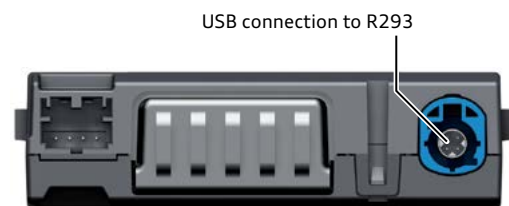

USB Connection 1 U41 (rear)

666_017



Note

The optional Audi smartphone interface (IU1) can only be used via the two front USB connections in R293.

DVD Changer R161

The optional DVD changer R161 is also used on the Audi Q7. This drive is a dedicated DVD video drive which only allows playback of video DVDs and audio CDs.

R161 is connected to J794 via the MOST bus. It is located between the rear seat backrests.

It is diagnosed via Address Word 000E - Media player position 1.



DVD Changer R161

666_020



DVD Changer R161 (rear)

666_021

Radio

Introduction

The following new features are being introduced to the entire radio system as part of MIB2+:

- > DAB tuner (3x).
- > One station list for FM, DAB and Internet radio stations.

All functions are implemented by Information Electronics Control Module 1 J794. These can be diagnosed via Address Word 005F using the VAS Scan Tool.



Menu for selecting radio source

666_038



Radio station list

666_119

DAB tuner

With MIB2+, a third tuner and a second DAB antenna have been added to the DAB radio.

Tuners 1 and 2 receive the signal of the station currently selected and decode it. The bits of both tuners are then compared in the MRC module (maximal ratio combining). If it is determined that bits are missing in a tuner, they can be replaced with the bits from the other tuner. This creates better reception.

In the background, tuner 3 searches for new stations to keep the station list continually updated. In addition, it provides the navigation unit with traffic information.

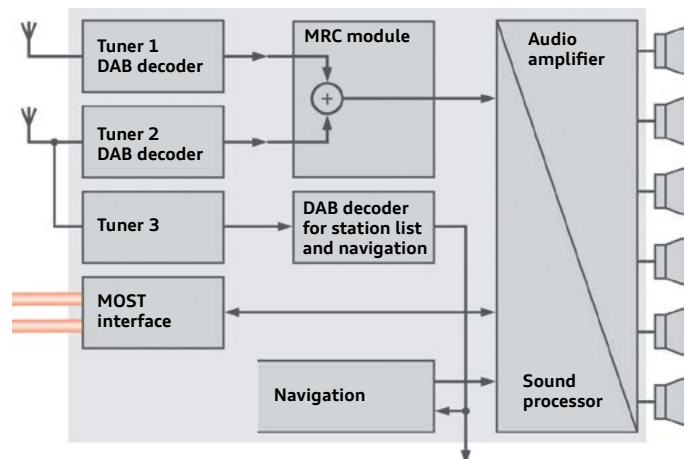

Illustration of DAB tuner (example)

666_039



Reference

For further information on the radio tuner, please refer to eSelf-Study Program [970143, Modular Infotainment Platform \(MIB\)](#).

Navigation

With MIB2+, Audi is making use of “connected navigation”.

- › Online routing (cloud-based route calculations)*.
- › 3D city models in some towns/cities with detailed and accurate depictions of streets and buildings.*
- › Connected POIs with additional information on the map.*
- › Traffic sign information.
- › Hazard alerts.*
- › Navigation display with Google Earth.*

*These items require Audi connect PRIME.

Route calculation

Route calculation takes place in Information Electronics Control Module 1 J794. This is where the map data is stored.

If there is an existing data connection, (that is. Audi connect PRIME) a route is calculated on a central Audi server at the same time. The calculation on the server is quicker than the one in J794, particularly when the destination is far. In addition, the calculation takes the entire traffic situation into account. The same map data as in J794 is used for the online route calculation.

As a result, the driver is offered up to three alternative routes. There is no longer an option to set route types such as “short”, “fast”, or “economical”.

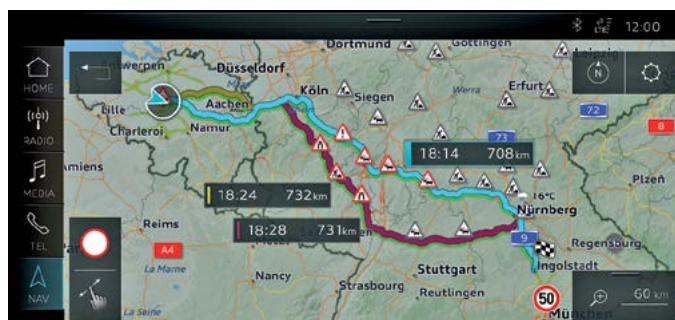

666_088

Connected Points of Interest (POIs)

In MIB2+, selected Audi connect services (for example, fuel prices, parking information, etc.) have been integrated in the navigation function.

Additional information on certain POIs is displayed directly in the list or when a POI is selected on the map.



666_089

New feature in route guidance

Maneuver preview

The maneuver preview has been reduced to the next two actions. If desired, the user can extend the preview to 10 maneuvers.

Manual traffic avoidance

A corresponding display on the right side menu helps the driver with manual traffic avoidance. It calculates the actual time saved if the alternative route were used.

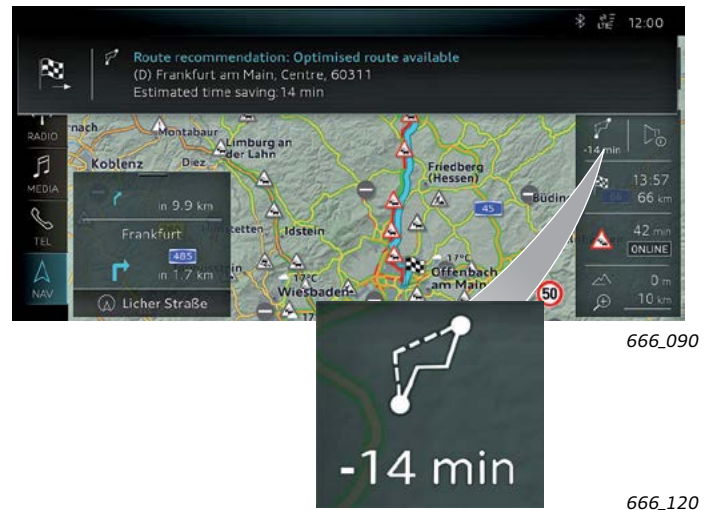

Personal route assist

J794 identifies routes which are driven repeatedly and suggests possible destinations. If there are potential delays on routes that the system suspects the driver may take, it will automatically suggest alternative routes, even when route guidance is not active. This "self-teaching" navigation system is referred to as personal route assist in MIB2+.

If the personal route assist function is deactivated, a selection field appears on the right side showing a checkered flag with a light bulb. To activate the function, the customer can simply tap the field.



Optimized position detection

With the introduction of Driver Assistance Systems Control Module J1121, the vehicle can be localized to a specific lane. J1121 makes the necessary calculation and sends the information to J794 which can then provide a lane-specific display. This is shown in the "exit views"¹⁾, both on the Audi virtual cockpit and the head-up display.

Despite the display being precise to a specific lane, spoken cues may be given which appear unnecessary to the driver because the car is in the correct lane. If the vehicle drives past an exit, for example, the spoken cue will still tell the driver to keep left.

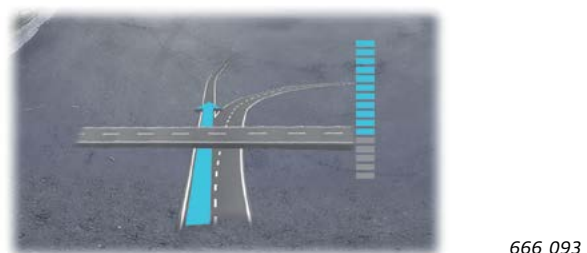

¹⁾ Exit views refer to leaving highways and major roads.

Navigation information

Navigation data storage

At the launch of the Audi A8, J794 will have up to 25 GB of navigation data stored. In addition, 15 GB are kept available for cached navigation information (Google, 3D city data, online hazard alerts etc.).

The maximum space available for the navigation system on the SSD ↗ is approximately 64 GB of the 128 GB available in total.

Map update

MMI navigation plus customers will receive a free 6 month trial of Audi connect PRIME. As long as the subscription is active, the customer will receive free navigation updates. For the latest information on the various Audi connect offerings, refer to the Audi connect portal. <https://www.audiusa.com/technology/intelligence/audi-connect>

The navigation data have been changed to a new format for MIB2+. This “navigation data standard” (.nds) format allows incremental updates. These are updates which only affect the data which have changed, allowing updates to be quicker. In addition, the geographic regions have been made smaller. This helps to accelerate the update process. The average size of the update data is now 10% of the previous amount.

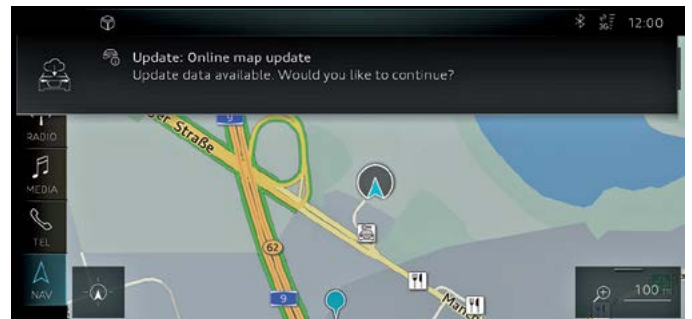

666_095

Display and operating units

Introduction

Audi is taking a new path with the 2019 Audi A8 and is introducing **touch displays** for the first time. For marketing purposes, these are referred to as “MMI touch response”. They are multitouch displays; this means that they can be operated with several fingers at once.

Two high-definition displays are installed in the Audi A8. The upper display (“MMI display”) is used to display the MMI. The lower display (“lower touch display”) is used, among other things, to operate the climate control.

The high resolution and small pixel dimensions of these displays are crucial for a very clear picture: the human eye is not capable (at the typical distances in the vehicle interior) of detecting the individual pixels from which the image is constructed.

The maximum brightness is 900 *candela* ↗. It can be adjusted on the MMI.

Technical features

MMI display Front Information Display Control Head J685.

- > 10.1 inch
- > 1540 x 720 pixels
- > Active area: 232 x 109 mm

Lower touch display Front Information Display Control Head 2 J1060

- > 8.6 inch
- > 1280 x 660 pixels
- > Active area: 194 x 100 mm

Networking

Both displays are controlled by J794 and connected to it via MIB-CAN. All fault memory entries and adjustments are stored/made in J794.

J794 sends a common image (a “superframe”) to the MMI display J685 via two LDVS wiring pairs. J685 then sends the part of the image for the lower touch display J1060 to that display via two LDVS wiring pairs.

To ensure that they are not mis-connected, the two LVDS connectors on J685 are of different colors.



666_013

Front Information Display Control Head J685



Front Information Display Control Head 2 J1060

666_014

Function

There are pressure sensors behind the touch-sensitive display surface. They enable the MMI to be used more safely as they allow the user to move fingers over the display without making undesired inputs. The system only reacts to a specific amount of pressure or more on the display; this is detected by the pressure sensors.

To provide the user with tactile and audible feedback simulating the touch of a button, an electromagnet and a speaker are integrated into each display. If the pressure sensors detect that the screen has been pressed intentionally, the electromagnet moves the surface of the display very slightly sideways. The speaker plays a clicking sound. This haptic and acoustic reaction is the feedback typical to Audi.

It is possible to set the level of pressure which has to be exerted on the display for feedback to be given. There are three levels for this.

The feedback can be deactivated in steps as follows:

1. Haptic feedback
2. Acoustic feedback

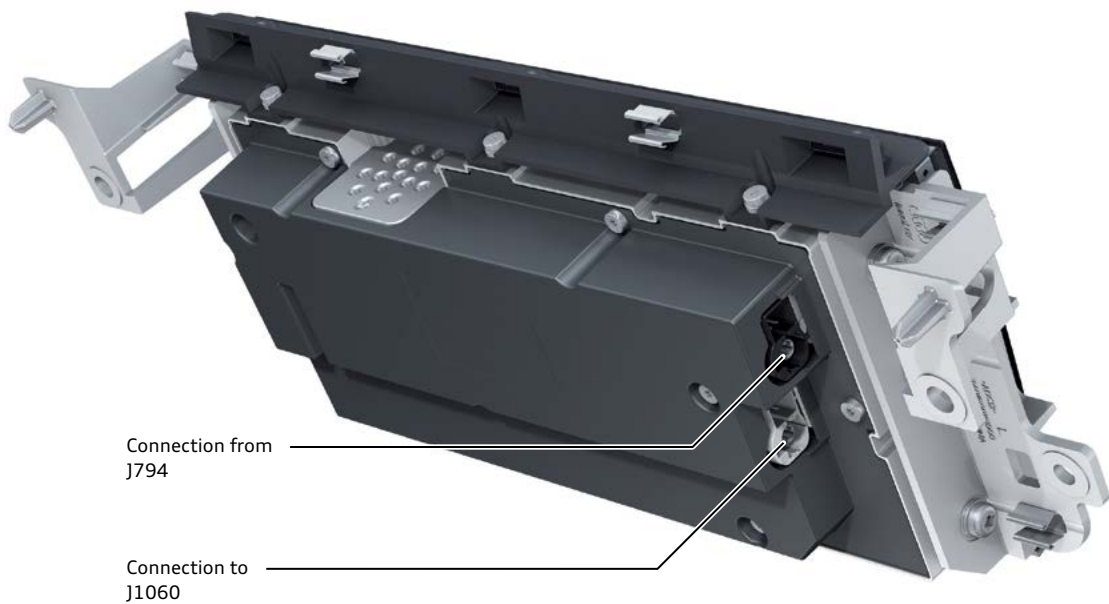

666_042

Front Information Display Control Head J685 (rear)

Other features

Both displays have a special coating to make it easier to remove finger marks. There is a freeze function which allows the user to clean the surface of the display without making unwanted changes to the system.

J685 has hardened, shatter-proof glass which is capable of surviving an impact from a 15.4 lb (7.0 kg) metal ball travelling at 12.4 mph (20 km/h) undamaged.

For design reasons, the upper display is horizontally curved. This allows it to be integrated flush into the instrument panel.

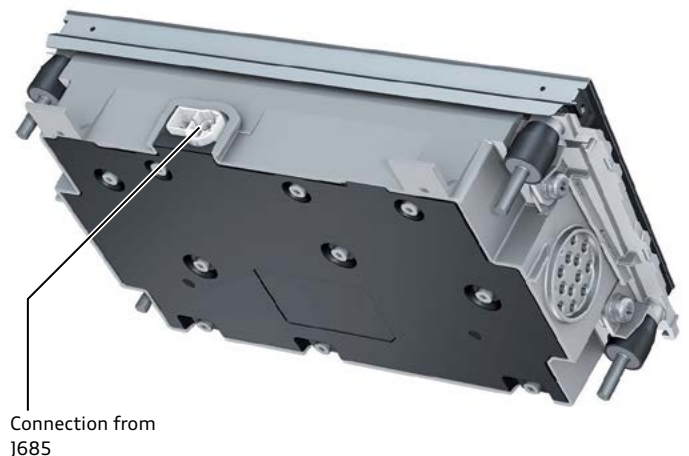

Front Information Display Control Head 2 J1060 (rear)

666_043

Button combinations for service

In the past, button combinations of the MMI operating units were used for certain functions, such as recording the current display on the MMI (screenshot). Other activation options have been introduced for the new touch display (MMI touch response). Procedures for service are given below.

System reset

To restart (reset) the MMI, press and hold the Driver Volume Control E67 for at least 10 seconds.



Driver Volume Control E67

666_044

Engineering menu

To access the engineering menu, touch the MMI display J685 at the top right with two fingers for at least three seconds.



Touch location for engineering menu

666_045

Screenshot

To make screenshots of both touch displays, touch the MMI display J685 with two fingers at the bottom in the center for at least three seconds.

Five images are stored in J794 at the same time. Two images are stored for each touch display; one screenshot of the screen display and one of the control areas. The fifth screenshot shows the image sent from J794 to the Audi virtual cockpit.

The display view flashes briefly to confirm that the screenshot has been saved.

The saved screenshots can be downloaded from J794 and copied to an SD card using the VAS Scan Tool through Guided Functions. This can be done via the selection "005F - Information electronics 1, functions", "005F - Basic setting" and, in the program sequence, via the option "Write analysis data on SD card".



Touch location for screenshot

666_046

Sound

Introduction

The following sound systems are available to Audi A8 customers:

- > Bang & Olufsen Premium Sound System with 3D sound (9VS) (16-channel)
- > Bang & Olufsen Advanced Sound System with 3D sound (8RF) (24-channel)

The Audi sound system (9VD) has 6 channels and 10 speakers with a total power output of 180 W.

The Advanced Sound System (8RF), has 24 channels and a total power output of 1920 W, shared between 23 speakers.

Both Bang & Olufsen systems can generate the third dimension of 3D sound using a special algorithm. To do this, the Premium Sound System has two speakers in the A-pillars; the Advanced Sound System uses four. The two additional speakers are in the headliner, behind the grab handles.

On the Bang & Olufsen Advanced Sound System, the two treble speakers in the instrument panel are retractable.

The subwoofer is under the rear shelf and installed in a special bracket.

In addition to the Vehicle Noise Cancellation function (VNC), some vehicles also have the Active Noise Cancellation function (ANC) (PR number EP1). Four microphones in the headliner record noises caused by the engine and initiate appropriate compensation noises.



Note

Active noise cancellation (PR number EP1) on V8 models only. Not available at launch.



Reference

For more information on the “Active Noise Cancellation” function, please refer to eSelf-Study Program [920223, The Audi 4.0L V8 TFSI Engine](#).

Bang & Olufsen Premium Sound System with 3D sound (9VS)

Right Front Midrange Speaker
R104

Right Front Midrange Speaker 2
R277

Right Front Treble Speaker
R22

Right Front Bass Speaker
R23

Center Speaker
R208

Center Speaker 2
R219

Left Front Treble Speaker
R20

Left Front Midrange Speaker 2
R276

Left Front Midrange Speaker
R103

Left Front Bass Speaker
R21

Left Rear Treble Speaker
R14

Left Rear Bass Speaker
R15

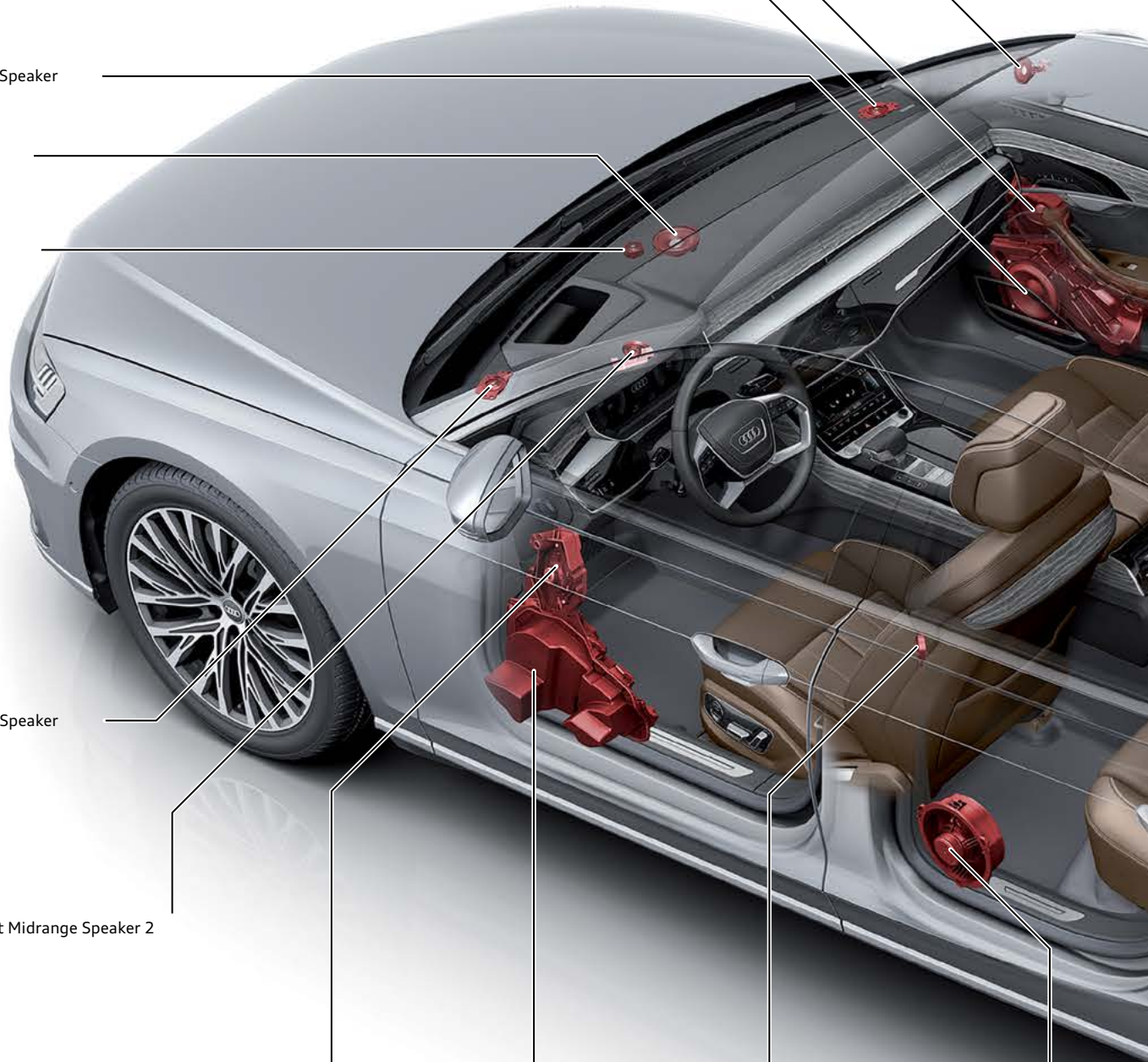



Bang & Olufsen Advanced Sound System with 3D sound (8RF)

Right Front Midrange Speaker
R104

Right Front Midrange Speaker 2
R277

Right Front Treble Speaker
R22

Right Front Bass Speaker
R23

Center Speaker
R208

Center Speakerr 2
R219

Left Front Treble Speaker
R20

Left Front Midrange Speaker 2
R276

Left Front Midrange Speaker
R103

Left Front Bass Speaker
R21

Left Rear Treble Speaker
R14

Left Rear Bass Speaker
R15

Left Rear Midrange Speaker
R105

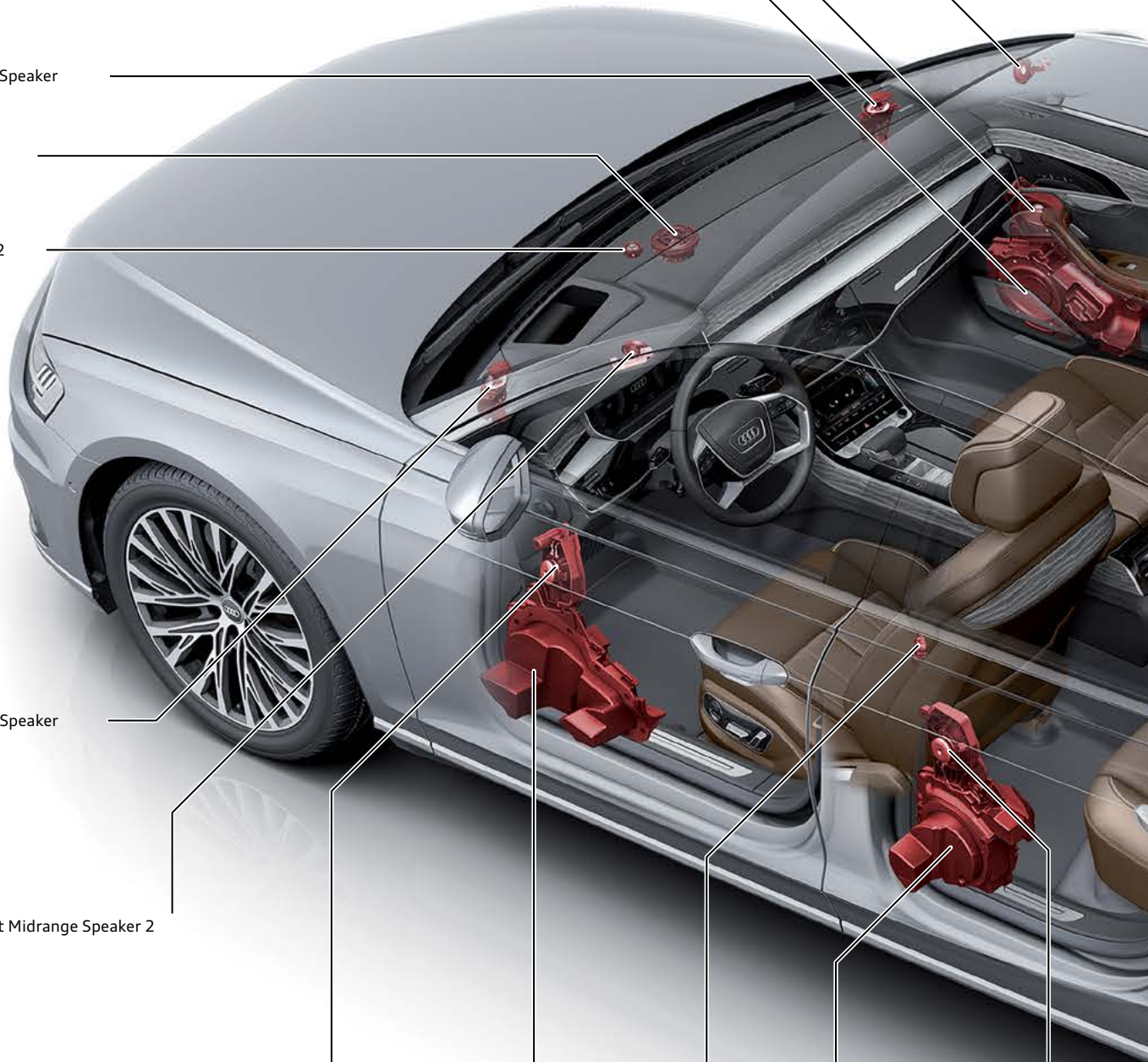

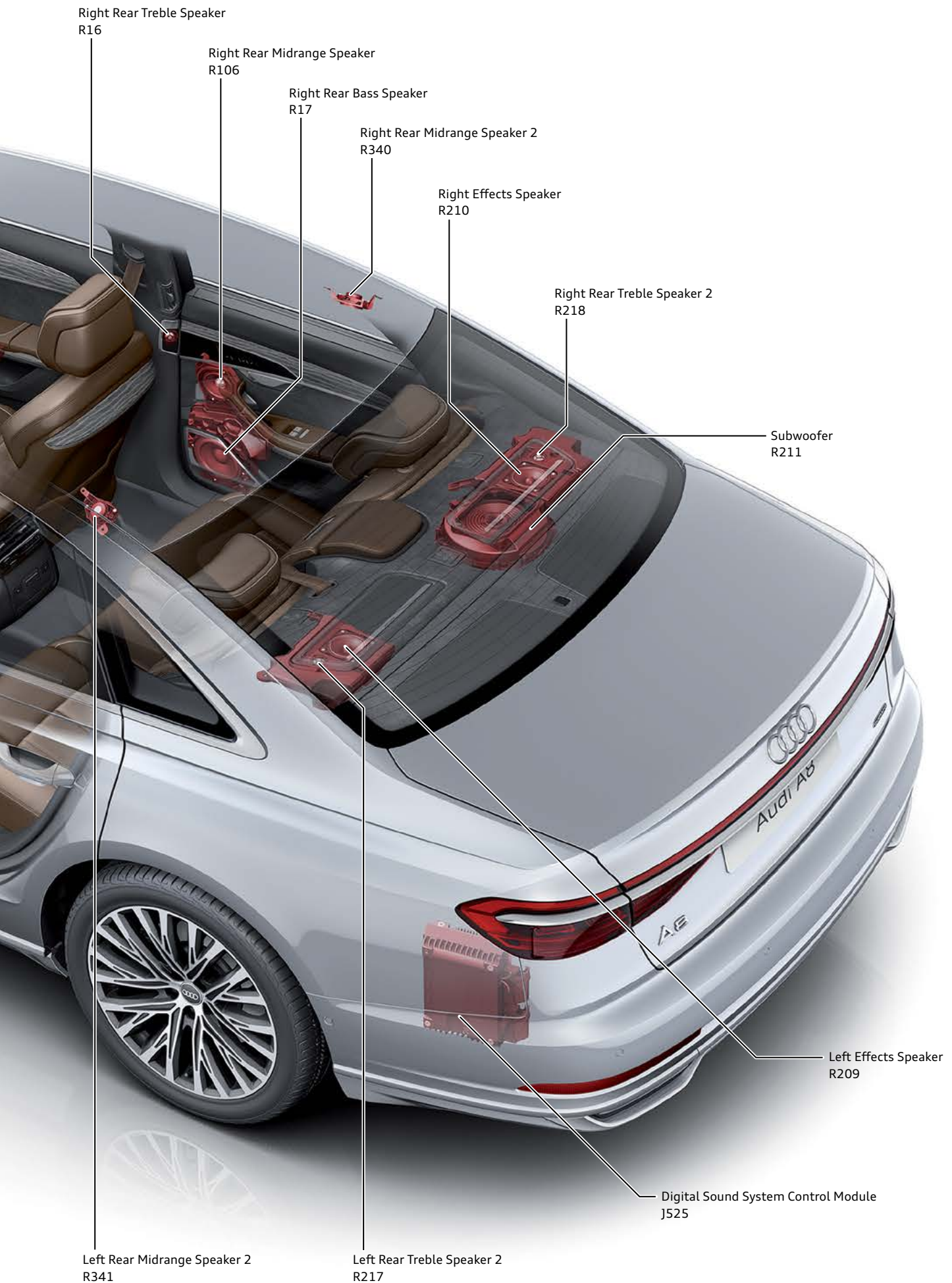

Right Rear Treble Speaker
R16

Right Rear Midrange Speaker
R106

Right Rear Bass Speaker
R17

Right Rear Midrange Speaker 2
R340

Right Effects Speaker
R210

Right Rear Treble Speaker 2
R218

Subwoofer
R211

Left Effects Speaker
R209

Digital Sound System Control Module
J525

Left Rear Midrange Speaker 2
R341

Left Rear Treble Speaker 2
R217

Antennas

Rear window

The antennas for radio reception are integrated in the rear window. There are differences depending on the window type. The Audi A8 has a total of three types of rear windows. The antenna structure is very similar on TSG¹⁾ and LSG²⁾ (privacy windows) (image 666_025).

This is not the case with insulated glass. Its particularly powerful heating wires are installed in a special foil and cannot be used as antennas (image 666_026, [page 27](#))

¹⁾ Tempered safety glass

²⁾ Laminated safety glass

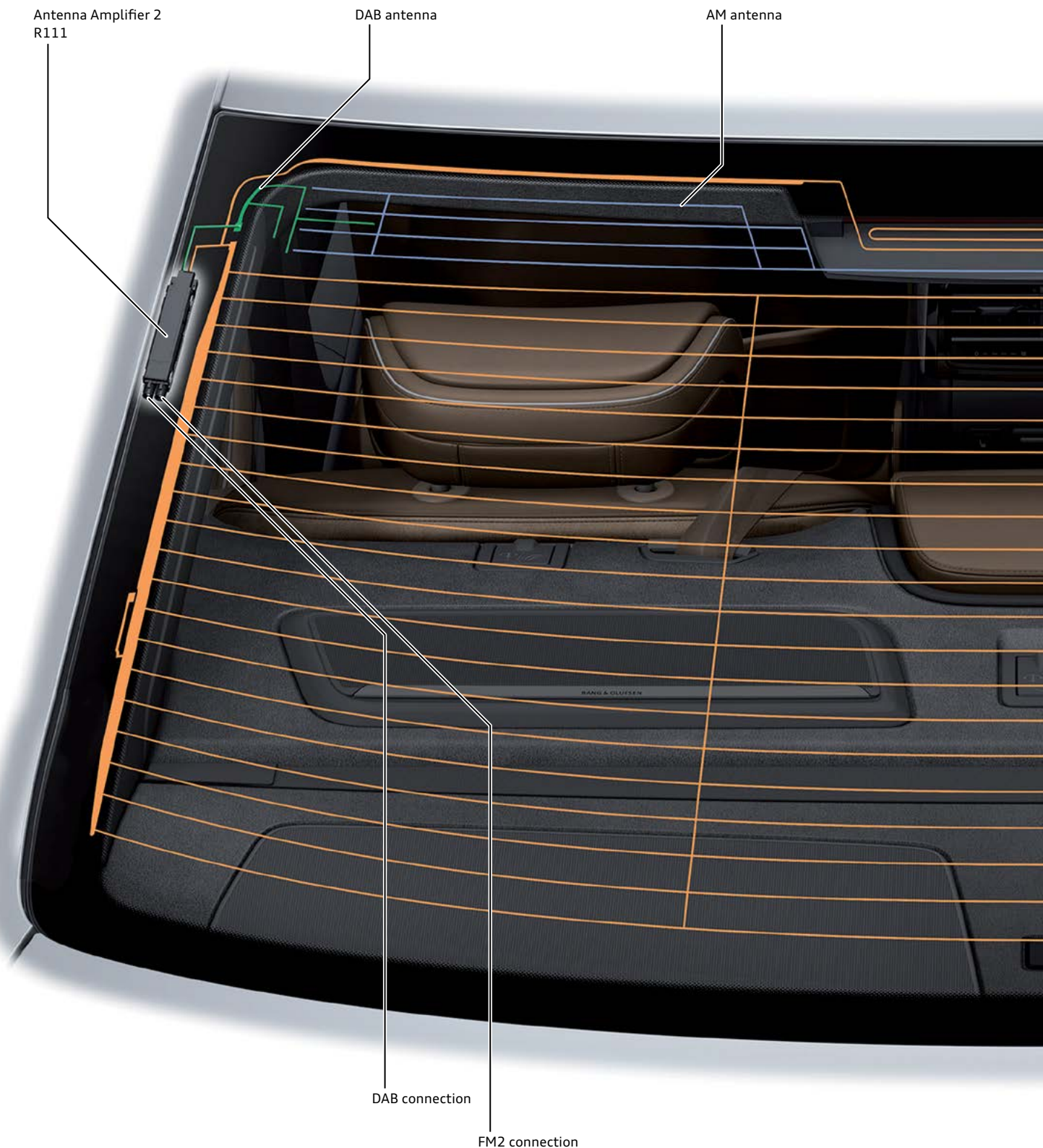

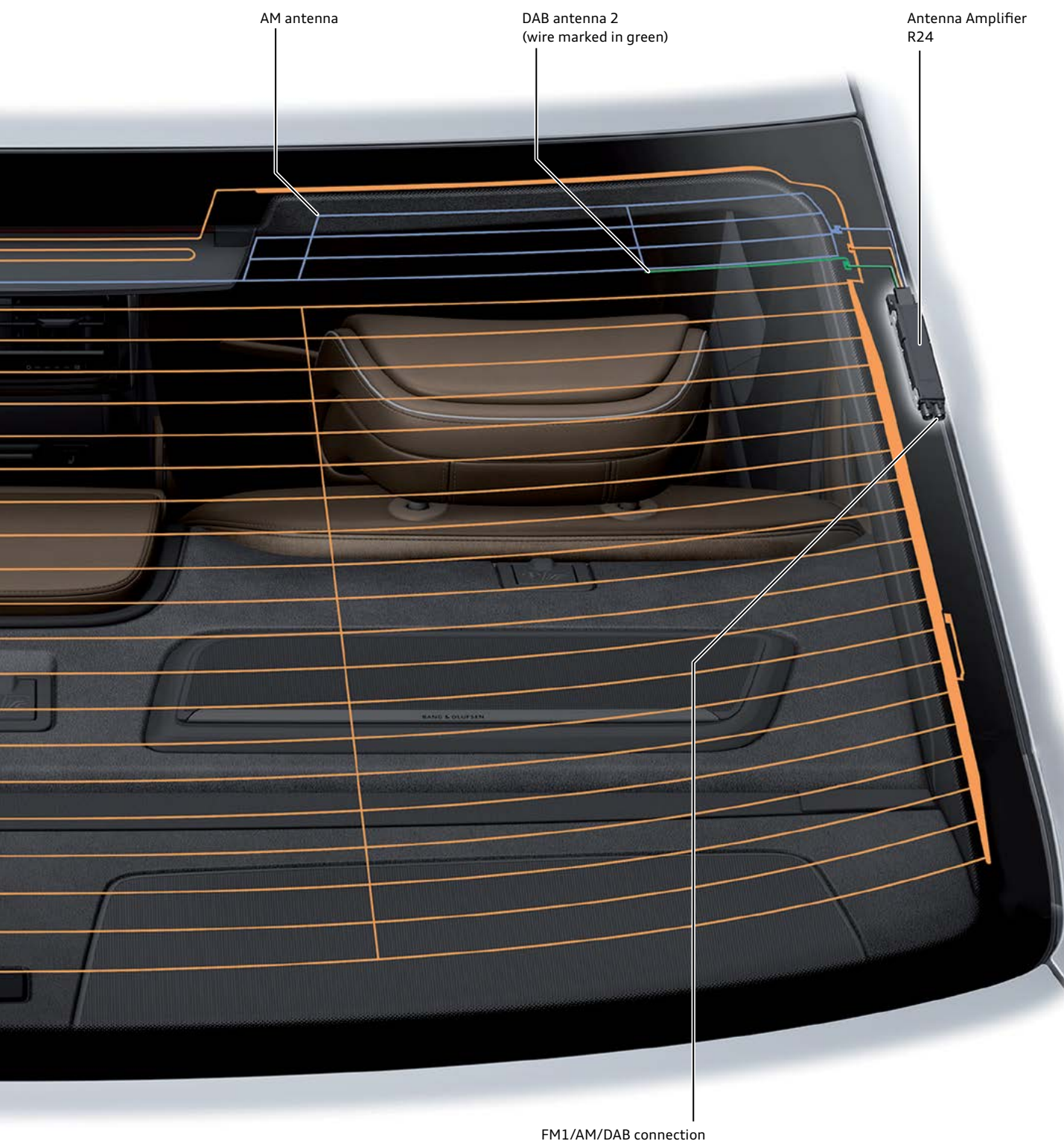

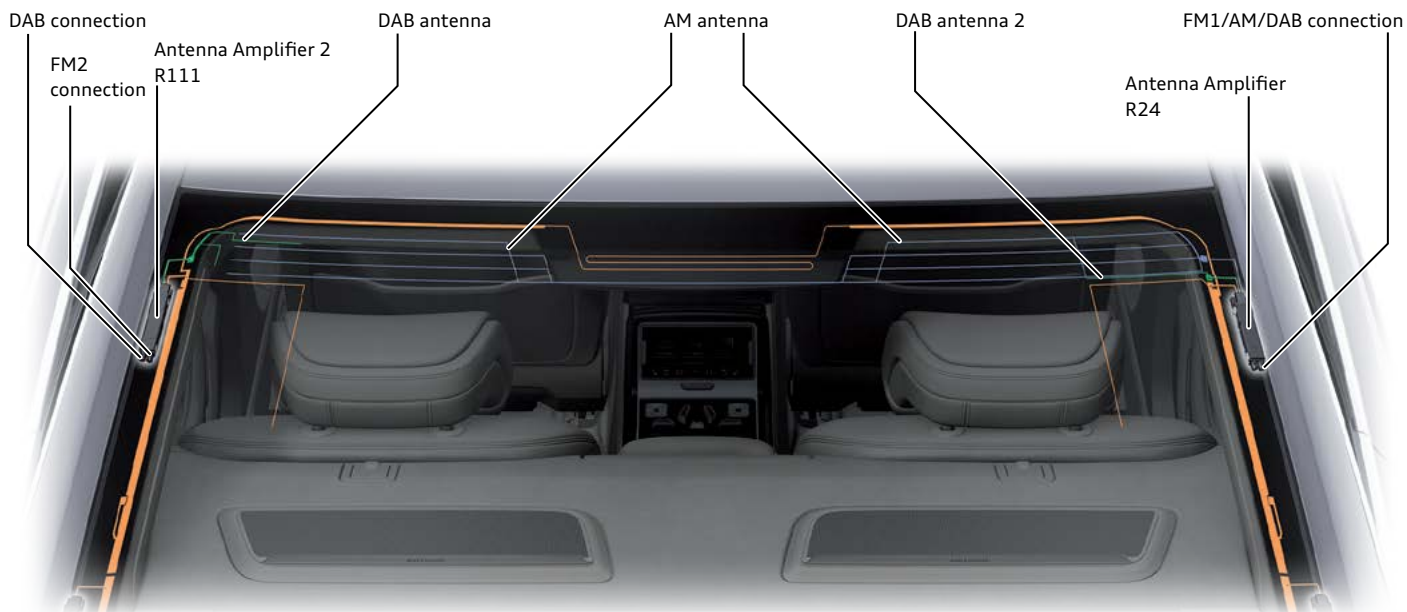

666_026

Bluetooth

The Audi A8 may be equipped with up to two Bluetooth antennas. One is used to connect external devices to the MMI and is located in Information Electronics Control Module J794. The second one is optional. It is integrated in the roof antenna and connected at Driver Assistance Systems Control Module J1121 (zFAS). Both antennas support Bluetooth Low Energy (standard 4.0). This standard provides for a maximum range of approximately 10.9 yd (10 m).

Wi-Fi

In the Audi A8, Vehicle Interior Communication Antenna R364 is located on the base of the interior rear view mirror. It is no longer in J794. It now supports two frequencies: 2.4 GHz and 5 GHz. This allows even better reception. The Wi-Fi standard is 802.11 ac. At 5 GHz, the data transfer is up to 300 Mbit/s.

If the conditions are met, the Audi tablet and the Rear Seat Remote always use the 5 GHz frequency. All other mobile devices which are connected to J794 via Wi-Fi determine which frequency to use themselves.



Reference

The Bluetooth antenna in the roof antenna is not yet available at the launch of the 2019 Audi A8 . Further information will be provided at a later date.

Roof Antenna

The following connections in the roof antenna are possible in North America:

- > SDARS
- > Navigation
- > Telephone

Because of the different openings on glass and steel roofs, there are different roof antennas for each version.

Antenna filter for GPS R110

If the Audi vehicle tracking system (PR number 711/712), the signal from the GPS antenna is split in GPS Antenna Splitter R110. The GPS signal is forwarded from R110 to J794 and J533 (connected gateway).

R110 is installed directly in the wiring harness. The antenna filter is a passive component and does not have self-diagnostic capability.

Diagnosis of the GPS antenna is performed by J533. If there are problems, R110 should be considered.

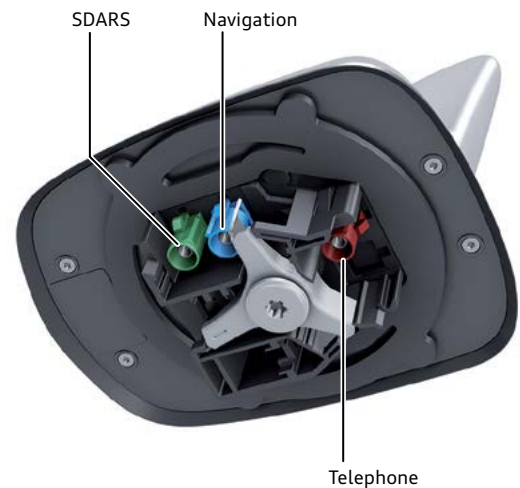

Roof antenna (glass roof, North America)

666_028

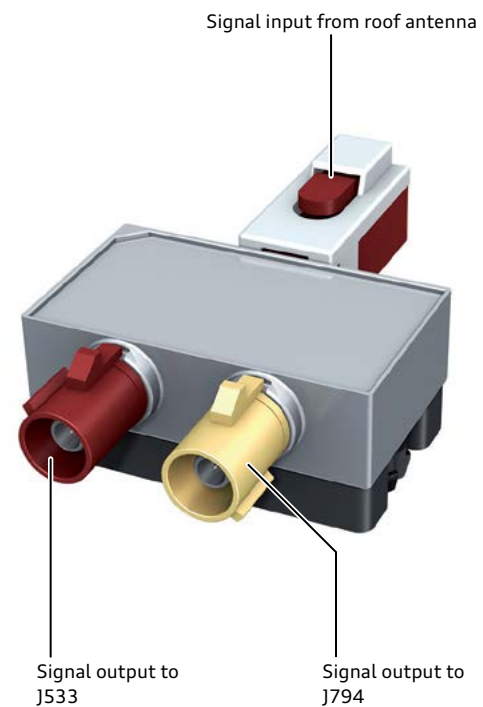

GPS Antenna Splitter R110

666_029

Mobile phone antennas

The roof antenna of the 2019 A8 is used for both Information Electronics Control Module 1 J794 and Data Bus On Board Diagnostic Interface J533. In most cases the signal from the roof antenna is sent from J533 directly to J794. If J533 requires use of the roof antenna, for example, in the event of an Audi emergency call, the connection to J794 is ended.

A second antenna is connected to J533. It is installed in the rear bumper. J533 determines which of the two antennas to use for communication based on the signal strength.

The LTE Advanced standard with carrier aggregation is used in the Audi A8. In this system, the signal is not transmitted via only one channel, but via several at the same time.

This increases the *bandwidth* \nearrow accordingly and allows for higher data transfer rates. Data transfer rates of up to 300 Mbit/s can therefore be achieved.

The number of mobile phone antennas in the Audi A8 is variable. Depending on the vehicle's equipment, there may be up to three antennas in the bumper, one on the roof and one under the rear right side window.

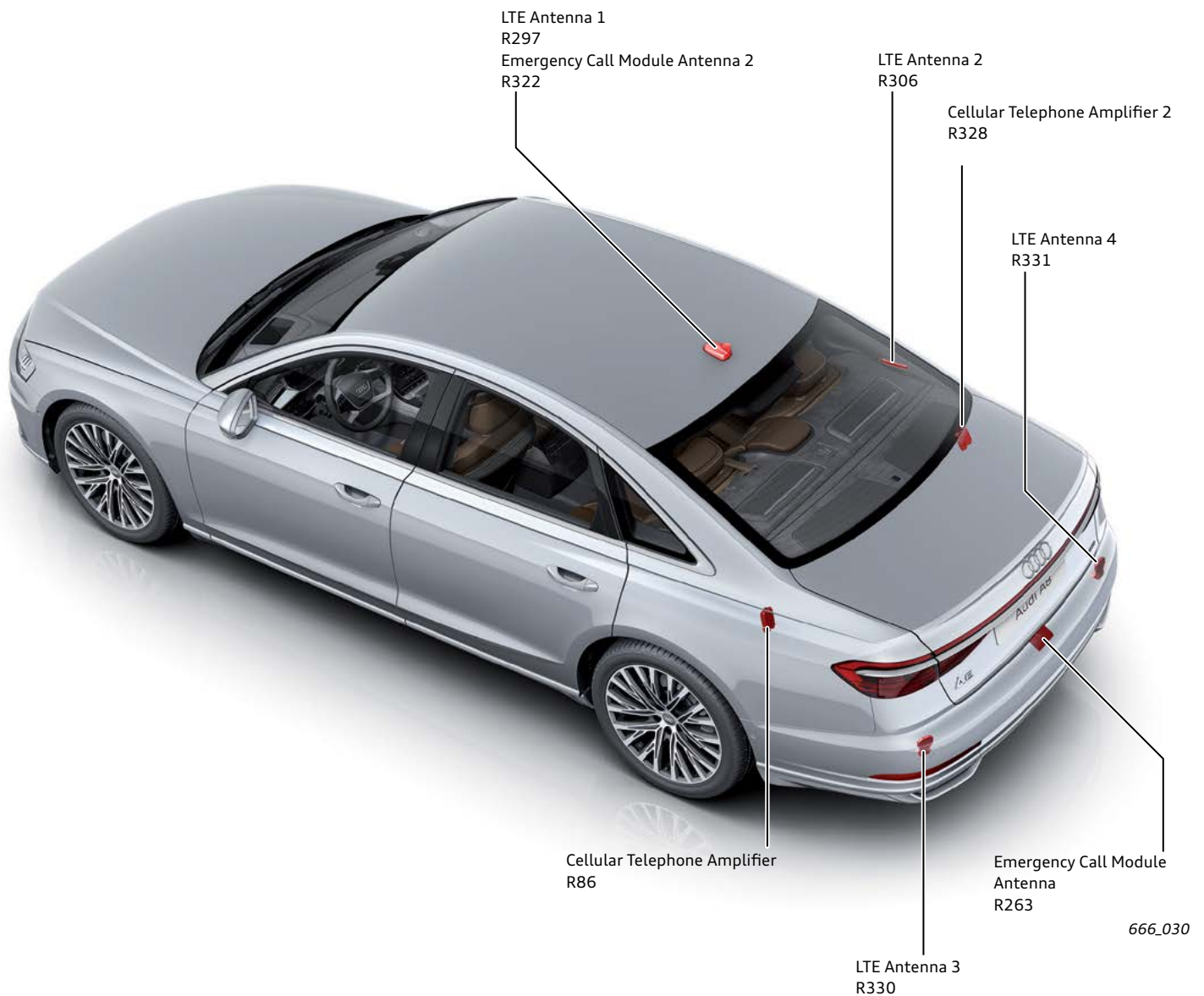

Versions

Diagrams of antenna configurations are provided below. They depend on the vehicle's equipment. The maximum possible number of antennas is shown.

Vehicles without Audi connect vehicle-related services (IW0)

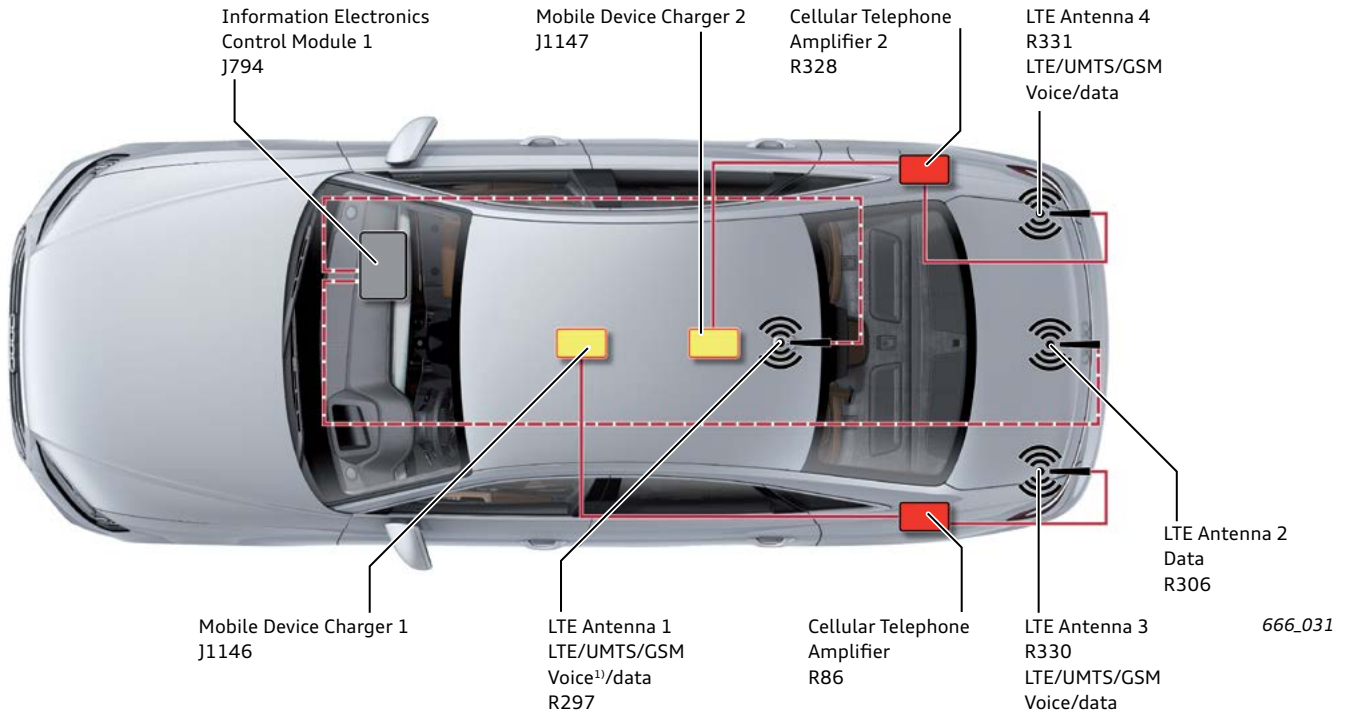

Vehicles with Audi connect vehicle-related services (IW3)

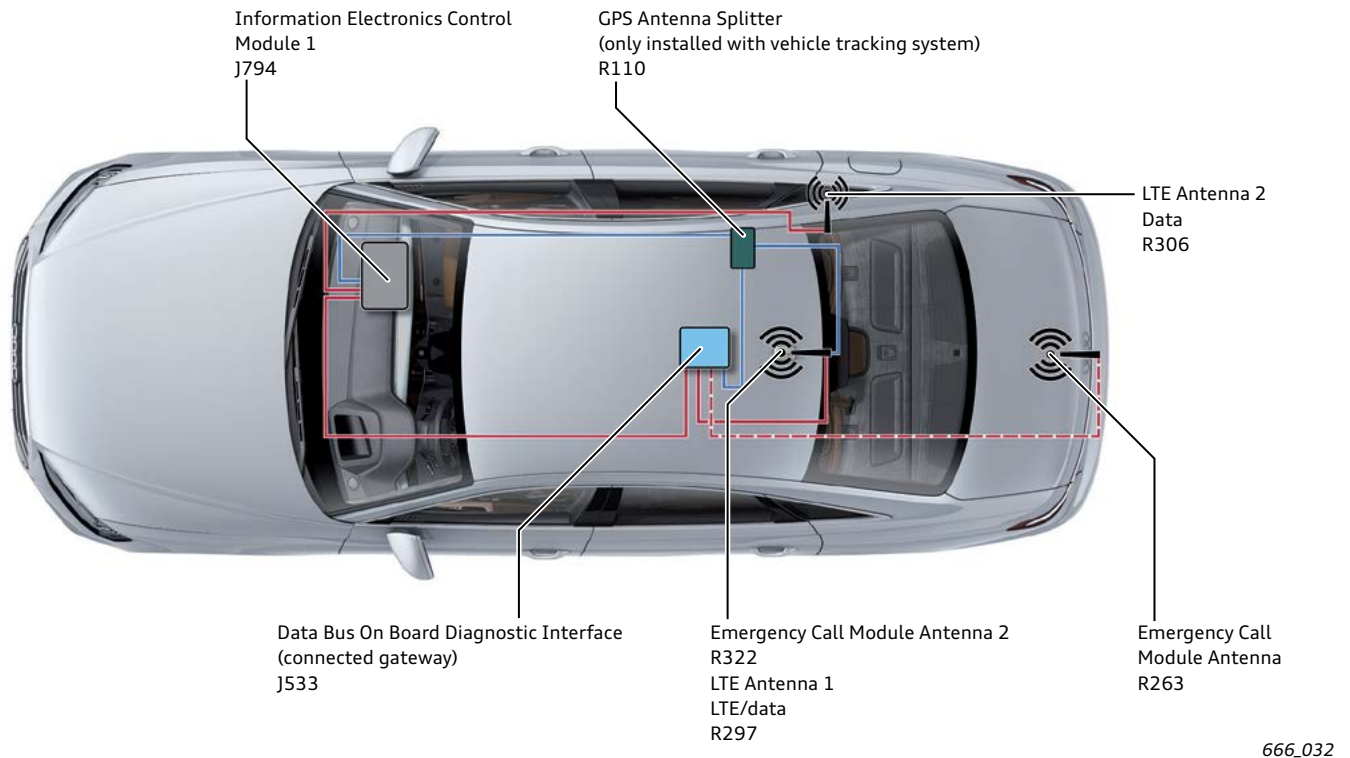

Note

For better clarity, the optional Audi phone boxes are not illustrated on the image "Vehicles with Audi connect vehicle-related services".

Audi phone box

General information

Up to two Audi phone boxes are available for the Audi A8. Both are capable of self-diagnosis at Audi (for the first time at Audi) and participants in MIB-CAN.

The designation in service is:

For the front Audi phone box:

- > Mobile Device Charger 1 J1146.

For the rear Audi phone box:

- > Mobile Device Charger 2 J1147.

Depending on the vehicle's equipment, the control module hardware may be identical. Because of the different diagnosis Address Words, they must be installed in the correct location. They have different part numbers to help ensure that they are not interchanged.

In the Audi A8, the Audi phone box supports the LTE standard along with GSM and UMTS. LTE-enabled compensators (antenna amplifier for mobile telephone) are installed for this.

The Qi standard is supported for the wireless charging function.

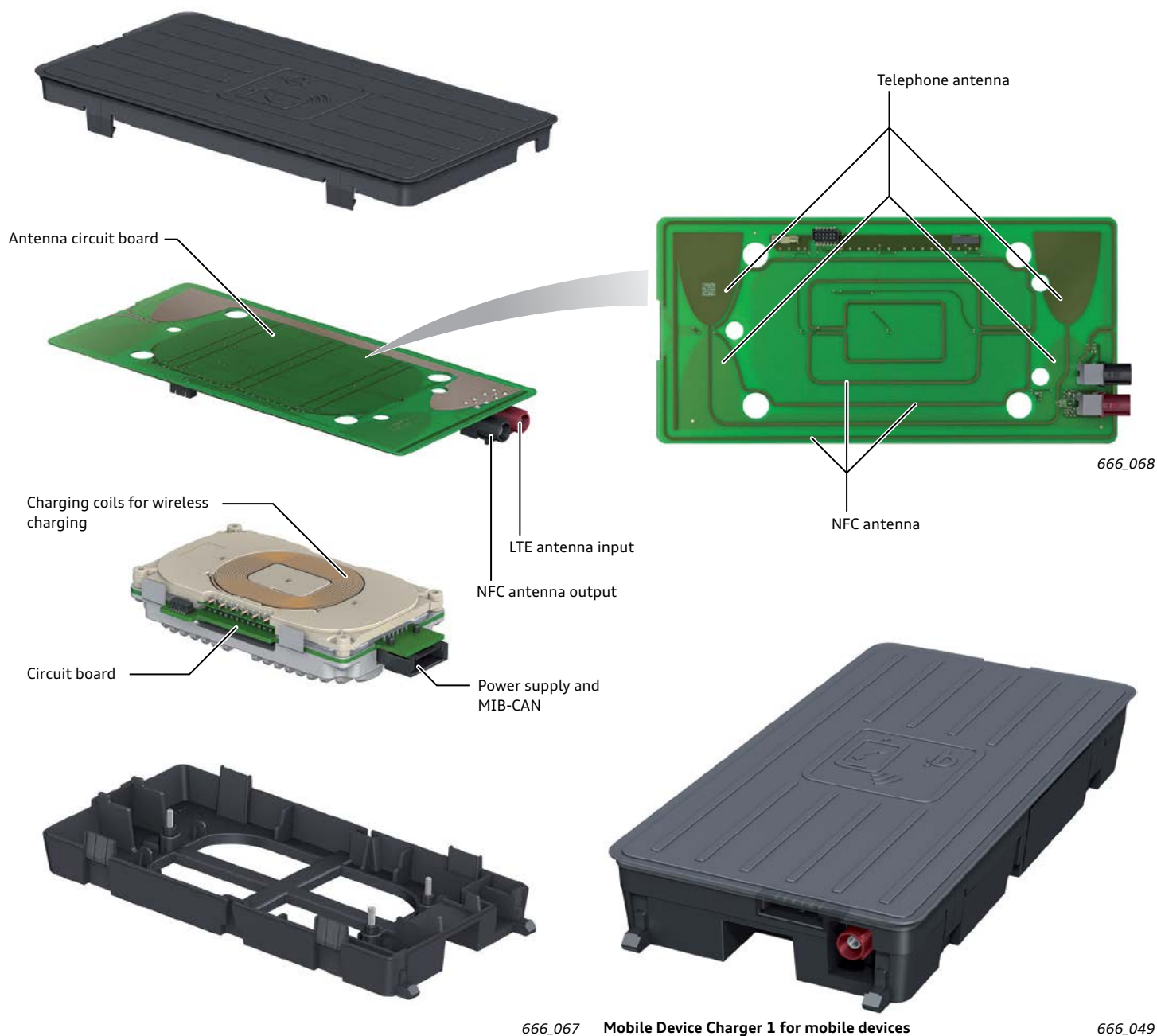

Mobile Device Charger 1 J1146

The Audi phone box is available in the following option dependent versions:

- > With external antenna connection and wireless charging (9ZE).
- > Without external antenna connection, wireless charging only (9ZV).

The display showing information on the charging status of a smartphone in the front Audi phone box is displayed in the MMI menu.

The compensor belonging to the charging unit J1146 has the designation Cellular Telephone Amplifier R86.



Mobile Device Charger 1 for mobile devices with Audi connect key

666_050



Cellular Telephone Amplifier R86

666_069

Mobile Device Charger 2 J1147

Three option dependent versions of J1147 are available:

4-seat vehicle

- > Wireless charging only (QF6).
- > External antenna connection and wireless charging (QF7).

5-seat vehicle

- > External antenna connection only (QF8).

On 5-seat vehicles, the rear Audi phone box is installed in the center armrest. Wireless charging is not available here because of cooling difficulties. The rear Audi phone box only has the external antenna connection; its PR number is QF8.

The display showing information on the charging status of a smartphone in the rear Audi phone box is shown on the Rear Seat Remote.

If the rear Audi phone box is not equipped with wireless charging, it is no longer a CAN control module. Its designation is then Roof Antenna R126. R126 exchanges information with Information Electronics Control Module 1 J794 via a PWM signal.

The compensor belonging to Mobile Device Charger 2 has the designation Cellular Telephone Amplifier 2.



Mobile Device Charger 2 J1147

666_051



Note

The switch-on information for both compensors is still provided by Information Electronics Control Module J794 as a 12V signal.

Diagnosis

Address Word 00DE is used to diagnose Mobile Device Charger 1. Mobile Device Charger 2 J1147 is diagnosed via Address Word DF. Along with MVs, it is now possible to diagnose the external antenna.

Any software update for the mobile device chargers is always provided to the MMI via a full update.

Diagnosis for Telephone Baseplate R126 is done via Information Electronics Control Module 1 J794.



666_065

Function displays

The wireless charging function can be deactivated individually for front and rear if necessary.

If there is a smartphone with wireless charging function in the front Audi phone box, the charging function is shown on the front MMI display.

The Rear Seat Remote (SCON ↗) shows a corresponding display if a smartphone is in the rear Audi phone box.

A corresponding notification is given if a smartphone is left in the Audi phone box when the user is leaving the vehicle.

This notification is triggered for the front Audi phone box when:

- > A smartphone is in the front Audi phone box
- > Terminal 15 is off
- > The door is open (Terminal S off)

The notification is triggered for the Rear Seat Remote when:

- > A smartphone is in the rear Audi phone box.
- > A rear seat belt is unbuckled.
- > The corresponding rear door is open.

Phone box registration

When a customer purchases a vehicle equipped with a phone box, the phone box must be registered with their cell phone carrier. The registration information is entered on a form downloadable from ServiceNet.

Dealers will find the vehicle specific information on a sticker in the luggage compartment.



Notification on MMI display

666_054



Notification on Rear Seat Remote

666_055



Audi Phone Box Equipped Vehicles

Operation of the Audi Phone Box is subject to the following requirements of the Federal Communications Commission:

This is a CONSUMER device.

BEFORE USE, you MUST REGISTER THIS DEVICE with your wireless provider and have your provider's consent. Most wireless providers consent to the use of signal boosters. Some providers may not consent to the use of this device on their network. If you are unsure, contact your service provider.

You MUST operate this device with approved antennas and cables as specified by the manufacturer. Antennas MUST be installed at least 20 cm (8 inches) from any person.

You MUST cease operating this device immediately if requested by the FCC or a licensed wireless service provider.

WARNING: E911 location information may not be provided or may be inaccurate for calls served by using this device.

Make # _____

Model # _____

Serial # _____

CUSTOMER COPY v1.0

Rear Seat Remote

A Rear Seat Remote is available in the 2019 A8. The device is referred to internally as SCON (Smart Remote Control). It can be ordered as an option, but is required if the following equipment is ordered:

- > Telephone in rear.
- > 4-zone climate control.
- > Massage seats in rear.
- > Reclining rear seats.
- > Matrix reading lights in rear.



Rear Seat Remote in vehicle

666_058

Design

The Rear Seat Remote has two components: Auxiliary Display Control Head 1 E857 and Wireless Control Head 1 E589.

Remote control

With its 5.7" display, Wireless Control Head 1 E859 is similar to a large smartphone. Unlike a regular smartphone, however, it has been developed specifically for in-vehicle use and conforms to crash safety requirements.

The display is always in landscape format, with the exception of the telephone function, which is in portrait.

The remote control display has the following specifications:

- > *OLED* display ↗ with 1920 x 1080 pixels.
- > Permanently installed lithium-ion battery (2800 mAh).
- > Integrated speaker and microphone for telephone calls.
- > Wi-Fi connection to J794 via 5 GHz frequency.
- > Two volume buttons.

All information shown on the remote control and provided directly by the vehicle is received via the Wi-Fi hotspot of J794. For this reason, Wi-Fi must be activated in J794.



Wireless Control Head 1 E859)

666_059

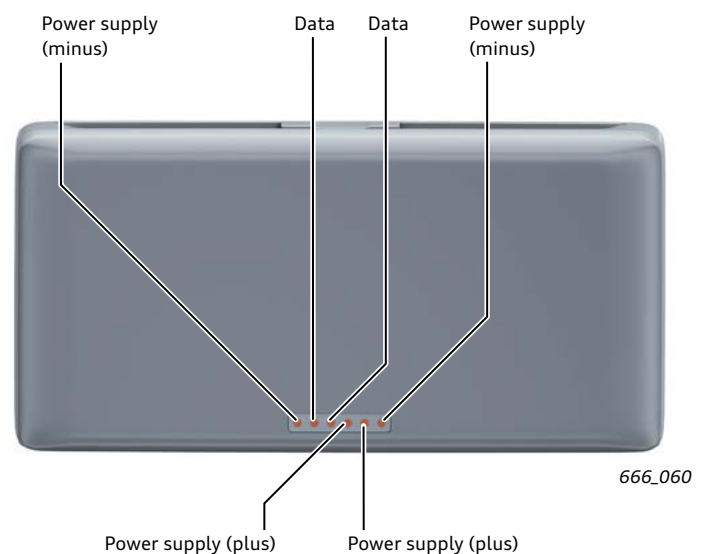

Connections on the remote control

666_060



Note

Only one telephone call at a time can be made via J794. It is not possible to have an active call in the front via the hands-free system and in the rear via the remote control.

Auxiliary Display Control Head 1 E857

Auxiliary Display Control Head 1 E857 serves as the remote control's mounting and power supply. It is also used for diagnostic functions and to bond a new remote control in the event of renewal.

The retainer is connected to Information Electronics Control Module 1 J794 via MIB-CAN.

A magnet in the retainer ensures that the remote control does not slip out when engaged in the retainer.

Function

The Rear Seat Remote can be used to control the following functions:

- > Telephone handset
- > Radio and media
- > Sound system
- > Rear climate control system
- > Massage seats in rear
- > Reclining rear seats
- > Seat adjustment
- > Rear seat ventilation
- > Passenger seat adjustment
- > Rear Seat Entertainment
- > Interior lighting
- > Matrix reading lights
- > Panorama sunroof
- > Rear and side window blinds

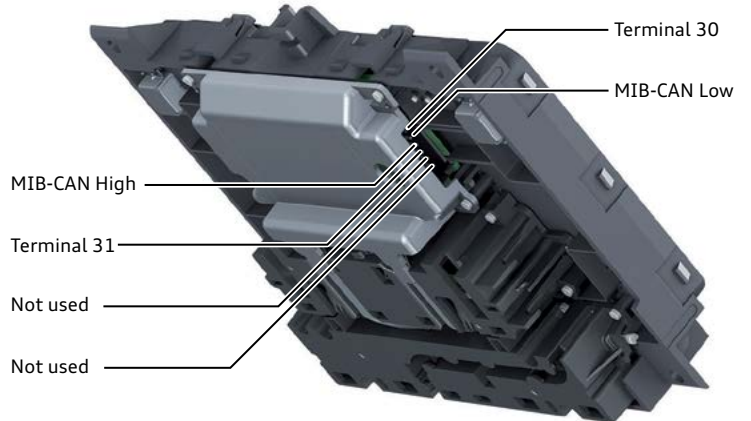

Auxiliary Display Control Head 1 E857 (retainer)

666_061

Telephone handset function

The remote control must be taken out of its retainer and held like a smartphone to be used as a telephone handset. The display is only switched to portrait mode for the telephone function.

The remote control does not have an integrated telephone module. It is designed as a separate handset for a smartphone connected to J794.

If the rear passengers do not wish for smartphone calls to be shown on the front MMI display, they can select "Private mode".



Telephone menu display

666_063

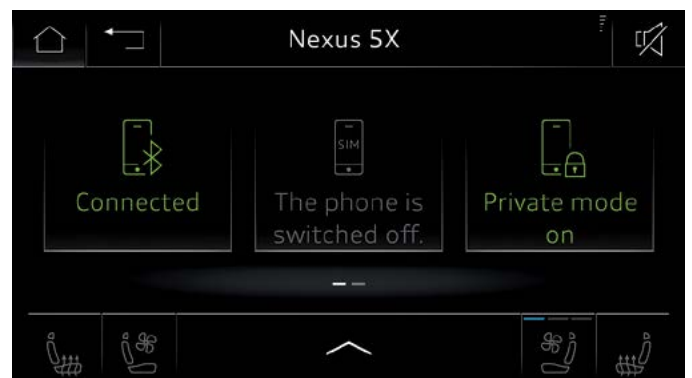

Display when private mode is active

666_064

Diagnosis

E857 and Wireless Control Head 1 E859 can both be accessed via Address Word 00E0 using the VAS Scan Tool.

The following functions are available:

- > Fault memory.
- > Measured value blocks.
- > Output check diagnosis.
- > Adaptation.

A software update for the Rear Seat Remote can only be performed in conjunction with an update of the entire infotainment system.

When needed, the right button (volume down) must be held to reset Wireless Control Head 1 E859.

A new remote control must always be adapted to the vehicle as it is a participant in the component protection process. Adaptation is done through Guided Functions via the Scan Tool. This process bonds the remote control to the vehicle via SVM (Software Version Management).



666_065



Note

Because there are no handsfree microphones in the rear of the Audi A8, the rear passenger can only make and receive calls using the remote control.

Networking









Topology

As many as 27 control modules are needed for all the functions of the infotainment and Audi connect systems in the 2019 Audi A8. The number of modules would of course increase if all those responsible for carrying out a service (for example, unlocking) were shown here. Therefore, this diagram only shows the control modules which are directly necessary in the maximum equipment version.

Information Electronics Control Module 1 J794 exchanges the majority of data with other control modules via the MOST or CAN buses. Exceptions to this include various image data and software update data for Instrument Cluster Control Module J285 and Driver Assistance Systems Control Module J1121.

A new type of data connection (Ethernet) has been added to J794. It is currently used to transfer data for a J794 software update to Driver Assistance Systems Control Module J1121 (zFAS). J794 receives the data from an SD card inserted in the USB hub.

Transfer rates of individual bus systems:

Bus system	Wire color	Data transfer rate ¹⁾
Infotainment CAN		500 kbit/s
Convenience CAN		500 kbit/s
MOST bus		150 Mbit/s
MIB-CAN (local CAN data bus)		500 kbit/s
Sub-bus system		500 kbit/s
Ethernet		100 Mbit/s
LVDS		
USB connection		
Composite video		

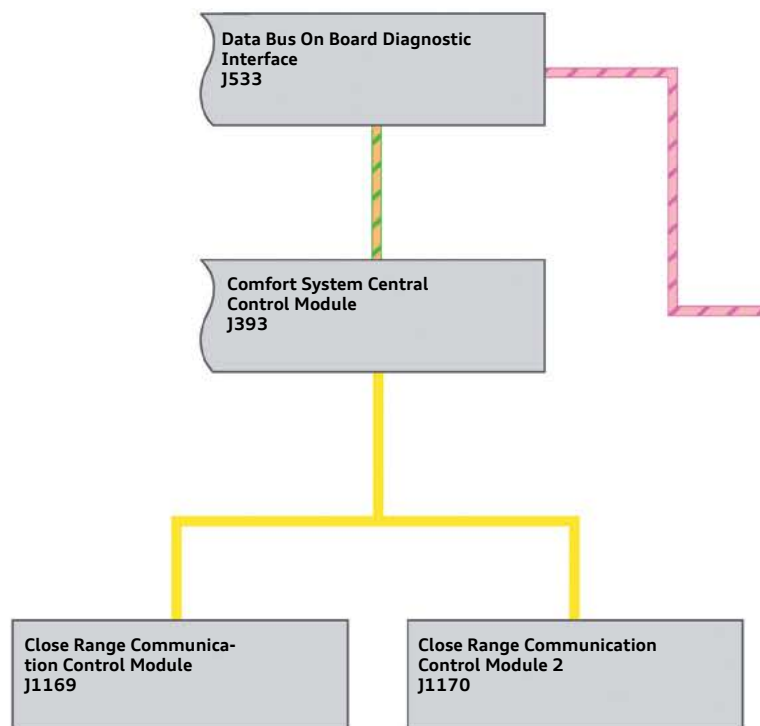
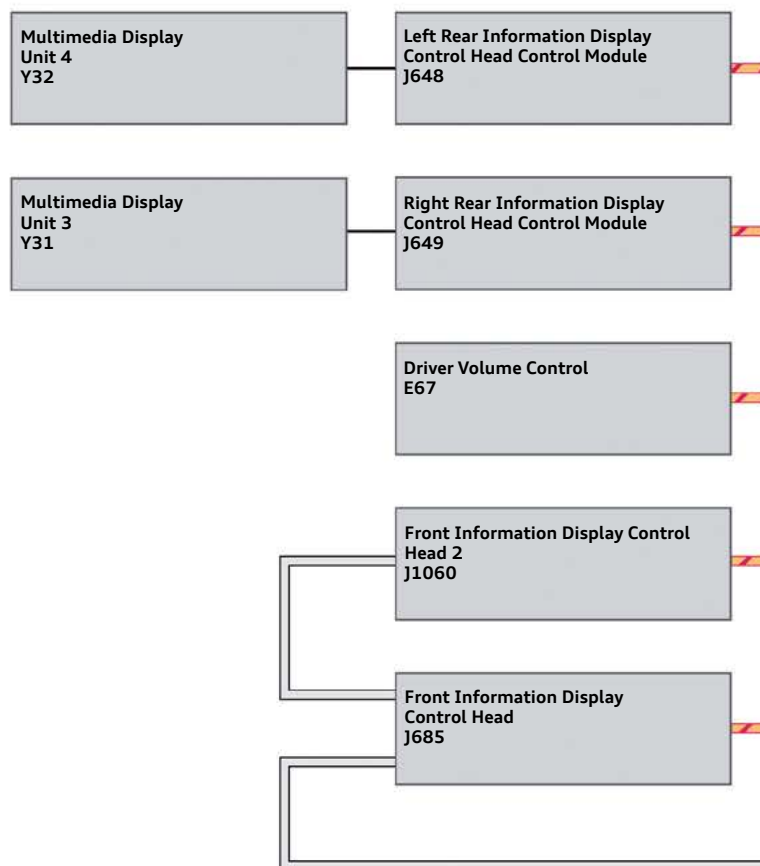

¹⁾ Connections only present if surround view cameras installed

²⁾ Only installed from control module version B onwards

³⁾ Not installed if surround view cameras installed

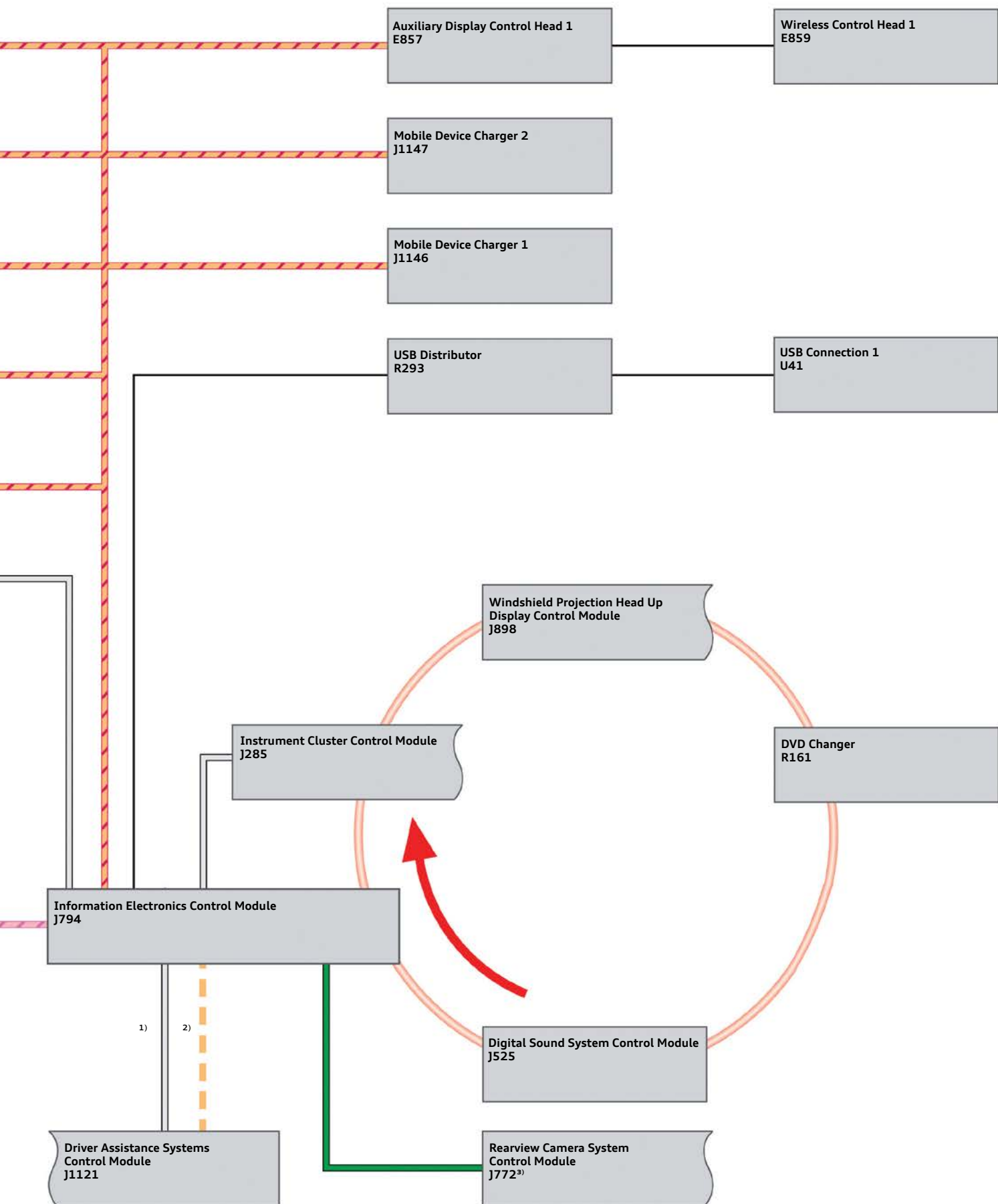

Image transfer

There are various image sources on MIB2+. They are sent to the devices on which they are displayed in different ways. The transfer methods are:

- › MOST bus.
- › LVDS.
- › Composite video.
- › Wi-Fi.
- › USB.

Information Electronics Control Module 1 J794

J794 receives image data from various sources, which it then forwards to other control modules.

The following control modules provide images and use the following transfer methods:

- › From mobile devices connected at USB Distributor R293 or USB Connection 1 U41, via USB.
- › From DVD Changer R161, via MOST bus.
- › From Driver Assistance Systems Control Module J1121, via LVDS.
- › From Rearview Camera System Control Module J772, via composite video.

Front Information Display Control Head J685

J685 receives image data for itself and Front Information Display Control Head 2 J1060 as one image from Information Electronics Control Module 1 J794 via LVDS. An integrated splitter separates this image into the section for J685 and J1060.

Lower touch display

(display unit 2 for Front Information Display Control Head 2 J1060)

The lower touch display receives the image data from the MMI display J685 via LVDS.

Instrument Cluster Control Module J285 (Audi virtual cockpit)

The Audi virtual cockpit receives image data from J794 via LVDS and MOST bus as follows:

- › LVDS:
 - › The large navigation map and the detailed intersection maps.
- › MOST bus:
 - › All other content, such as list menus or covers. In addition, the MOST bus is used to transfer data for software updates.

Windshield Projection Head Up Display Control Module J898 (Head up display)

Detailed intersection maps and highway exits have been added to the navigation information on J898 for the Audi A8. As the images consist of a large amount of data, J898 receives them from J794 via MOST bus.

Image transfer via Wi-Fi

Wireless Control Head 1 E859 (Rear Seat Remote) and Multimedia Display Units 3 and 4 Y31/Y32 (Audi tablets) receive display content from Information Electronics Control Module 1 J794 via Wi-Fi. The 5 GHz frequency is generally used to do this. Data are only sent via the 2.4 GHz frequency in countries where the 5 GHz frequency is not approved. The Audi tablets do not receive any videos via the 2.4 GHz frequency if they come from drives connected to J794 (DVD player, SD card reader, USB connection).

Rear Seat Entertainment

Rear Seat Entertainment

The Rear Seat Entertainment system consists of the Audi tablet in the Audi A8 . This is the second generation of the Audi tablet. It can only be ordered via PR number 9WF and is only available as a set of two. Its design and functions largely correspond to the MIB2 Audi tablet in the 2017 Audi Q7.

The difference compared to the MIB2 Audi tablet is in the menus; they have been adapted to the new MMI design.



666_097



Note

Films from video sources installed in the vehicle are transmitted via the 5 GHz Wi-Fi frequency.

Audi connect

Introduction

The Audi A8 with MMI navigation plus is equipped with Audi connect as standard.

In the Audi A8, a distinction is made within the Audi connect services between infotainment and vehicle-related services. The infotainment services are designed primarily for the customer's comfort and entertainment needs. The vehicle-related services, however, relate to the car, for example its position, condition, climate control, etc.

The infotainment services are operated via Information Electronics Control Module 1 J794 and the vehicle-related services via Data Bus On Board Diagnostic Interface J533.

Both control modules are equipped with their own embedded SIM card so that all Audi connect services and the Internet in general¹⁾ can be used without the use of external SIM cards.

The following conditions must be met to use certain vehicle-related services, such as "Remote locking/unlocking" or "Audi service request":

- > Verified user.
- > Key user added in the vehicle.

The Audi A8 may be equipped with up to two Bluetooth antennas. One of them is used to connect external devices to the MMI and is located in J794. The second one is optional. It is integrated in the roof antenna and connected to Driver Assistance Systems Control Module J1121. Both antennas support Bluetooth Low Energy (standard 4.0). This standard provides for a maximum range of approximately 10.9 yd (10 m).

Audi offers its customers a complementary six-month Prime Plus unlimited subscription. Dealership personnel must complete the Audi connect key user registration process at delivery in order to initiate this free trial. For more information, refer to the following website: <https://www.audiusa.com/technology/intelligence/audi-connect>









Reference

For further information on the Audi connect services, please refer to eSelf-Study Program [970663, The 2017 A4 Infotainment and Audi Connect](#).

CARE
(up to 10 years*)















Safety & Service

 Emergency Call	 Audi Service Request	
 Online Roadside Assistance	 Stolen Vehicle Locator	
 Remote lock & unlock		

PRIME
(free 6 month trial)

Navigation & Infotainment

\$199 for 6 month
\$499 for 18 month



 Google Earth™	 Point-of-interest search (POI)	 myAudi Google Maps	 Smartphone Calendar	 Weather	 Traffic Light Info
 Parking information	 Map update	 myAudi special destinations	 Online News (RSS)	 Online media streaming	
 Traffic information online	 Travel information	 Twitter	 Fuel prices		

Remote & Alert ★

 Vehicle status report	 Car finder	 Geofencing	 Valet Alert	 Speed/Curfew Alert
--	---	---	--	--

PLUS
(free 6 month trial)

WiFi

 WiFi dataplans (AT&T)	mobile share: \$10/mo unlimited: \$20/mo	 Amazon Music	 Online Radio
--	---	---	---

Seamless Mobility A6/A7/A8/Q7/Q8/e-tron/MY19

 Connected POIs	 Advanced 3D city view	 Predictive route guidance	 Natural voice recognition	 myAudi navigation
---	--	--	--	---

★ Key User Registration required

Using the Audi connect services

There is a significant change in the use of the Audi connect services in MIB2+: there is no longer an Audi connect menu and the majority of services are accessed via the corresponding function.

For example, fuel prices are now shown directly in the navigation function.

A small number of services which cannot be easily assigned to a specific function are shown separately in the main menu. Examples of these are the “News” and “Weather” services.

If desired, the customer can set shortcuts for these separately provided services on the left side of the MMI display.



Fuel price display

666_089



MMI menu with Audi connect services

666_099

Audi connect stolen vehicle locator

The optional stolen vehicle locator (referred to in some service literature as Vehicle Tracking System [VTS]) is one of the vehicle-related services. It is designed to allow the vehicle to be found quickly if it is stolen. The customer receives a complimentary 10 year license when the vehicle is first purchased.



Symbol for Audi vehicle tracking system

666_071

Layout in the vehicle

The vehicle tracking system has the following components in the vehicle:

- > Data Bus On Board Diagnostic Interface J533 (connected gateway)
- > Comfort System Central Control Module (BCM2) J393
- > GPS antenna
- > Mobile phone antennas
- > Driver card (712 only)

The following items have been added to Data Bus On Board Diagnostic Interface J533 for the vehicle tracking system function:

- > Gyroscope
- > Larger battery
- > VTS module
- > Direct connection of GPS Antenna via GPS Antenna Splitter R110
- > Software adaptations

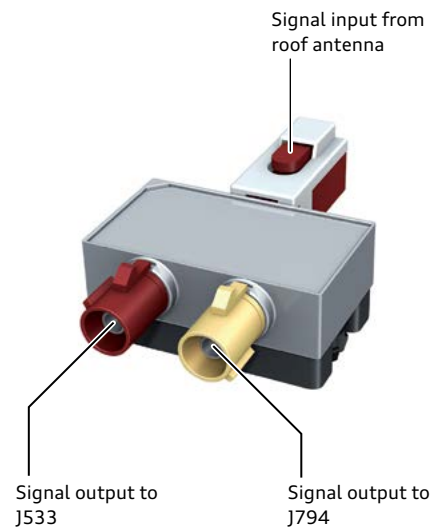
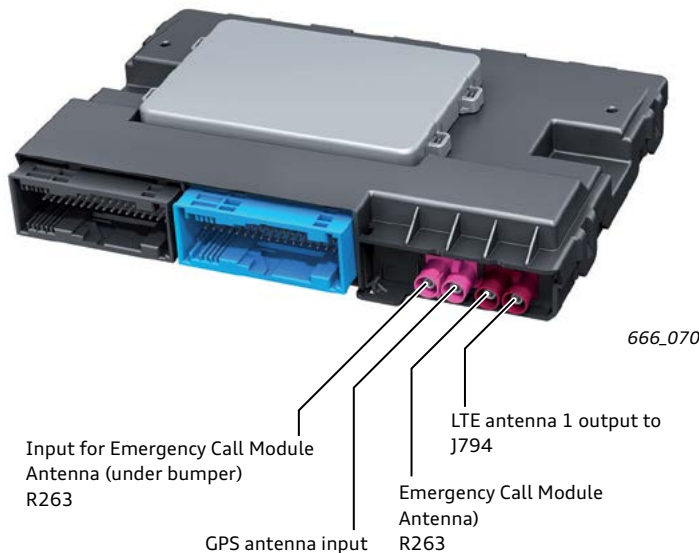

GPS Antenna Splitter R110

Data Bus On Board Diagnostic Interface J533

Function

With the Audi connect stolen vehicle locator system, there are two scenarios if a theft is suspected:

1. The owner realizes that the vehicle has been stolen.
2. The vehicle detects external manipulation.

1. The owner realizes that the vehicle has been stolen.

In this case, the customer must report this to the police immediately.

2. The vehicle detects external manipulation.

If the gateway (J533) suddenly loses its power supply (for example, if the battery is disconnected), it automatically sends data. The owner then informs the police immediately, so that the authorities can exchange data to track the vehicle.

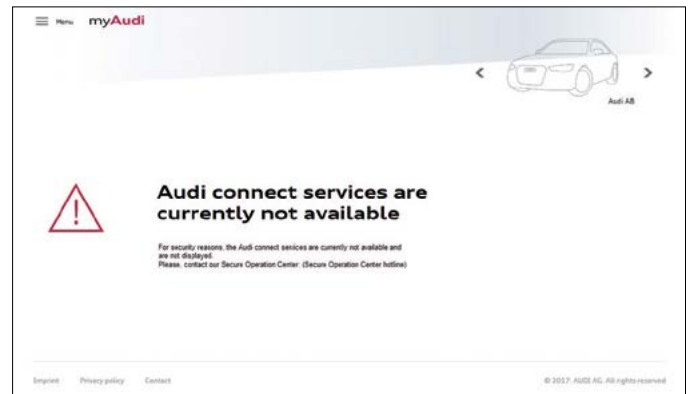

Display in myAudi after the theft report

666_111

Appendix

Glossary

This glossary explains all terms in this eSelf-Study Program which are written in *italics* and marked with an arrow ↗.

(ID3) tag

Additional information (for example, track, artist) in an MP3 file.

↗ **A2DP (Advanced Audio Distribution Profile)**

Bluetooth profile for the transmission (streaming) of Hi-Fi audio signals via a Bluetooth channel.

AAC (Advanced Audio Codec)

Compression standard for audio files used for example, by online music stores (iTunes among others) or online radio stations.

↗ **App (application)**

Application software for mobile devices

ADSPC (Audi Application Desk – Service Process for Customer)

Internal Audi hotline in the event of customer complaints about Audi connect (for Importer only!)

AcVDM (Audi connect Verification Data Management)

Audi tool to verify a user for myAudi.

asf (ASF = Advanced Streaming Format)

A digital audio and video format specially developed by Microsoft for streaming purposes.

ASX (Advanced Stream Redirecting)

Allows WMV or WMA files to be played back and combined in Windows Media Player.

Aux-In (Auxiliary)

Signal input to audio amplifiers to which any device with a line output can be connected.

AV input (audio/video input)

Signal input on video playback devices.

avi (AVI = Audio Video Interleave)

A video format defined by Microsoft that stores audio and video files together.

AVRCP (Audio Video Remote Control Profile)

Bluetooth profile to control audio and video devices.

↗ **Bandwidth**

The bandwidth is a frequency range within signal processing which is designed to transmit speech or data.

↗ **cd (candela)**

The “candela” unit (Latin for candle) refers to the light intensity that a light source can shine in a specific direction. A normal household candle has a light intensity of one candela.

↗ **CD (Compact Disc)**

An optical storage medium where data is burned onto a metal-coated plastic disc by means of a laser beam.

CD-R (Compact Disc Recordable)

CD which can be written to once only.

CD-RW (Compact Disc Rewritable)

Rewritable CD

↗ **CGW (connected gateway)**

Internal designation for a gateway with an integrated mobile network module required to use Audi connect vehicle-related services.

↗ **CI+ module (Common Interface)**

Is responsible for decrypting pay TV channels and can house an additional smartcard for additional pay TV channels.

↗ **Composite video**

Video transmission standard in which all signals are transmitted via a single cable.

↗ **DAB (Digital Audio Broadcasting)**

Digital transmission standard for the terrestrial reception of radio stations.

DAB+

An advanced version of DAB, which provides more radio stations per frequency.

↗ **Data transfer rate**

The data transfer rate is the amount of (digital) data which can be transferred in a specific unit of time.

DivX

A type of video compression which is used mainly to significantly compress large files at a good level of quality.

DMB (Digital Multimedia Broadcasting)

A digital transmission standard for the terrestrial reception of video and audio programmes.

DRM (Digital Rights Management)

A system to protect or be able to charge for for example, Media. One Internet example is Napster.

↗ **DVB-T (Digital Video Broadcasting – Terrestrial)**

Digital transmission standard for terrestrial television signals.

↗ **DVB-T2 (Digital Video Broadcasting – Terrestrial 2)**

Successor to DVB-T in Germany with which channels can be transmitted in HD quality.

↗ **DVD (Digital Versatile Disc)**

Further development of the CD with a capacity of 4.7 GB on DVDs with single layer coating (single layer DVD±R, DVD±RW) and 8.5 GB on DVDs with double layer coating (double layer; DVD±R-DL, DVD±RW-DL)

(ID3) tag

Additional information (for example, track, artist) in an MP3 file.

➤ A2DP (Advanced Audio Distribution Profile)

Bluetooth profile for the transmission (streaming) of Hi-Fi audio signals via a Bluetooth channel.

AAC (Advanced Audio Codec)

Compression standard for audio files used for example, by online music stores (iTunes among others) or online radio stations.

➤ App (application)

Application software for mobile devices

ADSPC (Audi Application Desk – Service Process for Customer)

Internal Audi hotline in the event of customer complaints about Audi connect (for Importer only!)

AcVDM (Audi connect Verification Data Management)

Audi tool to verify a user for myAudi.

asf (ASF = Advanced Streaming Format)

A digital audio and video format specially developed by Microsoft for streaming purposes.

ASX (Advanced Stream Redirecting)

Allows WMV or WMA files to be played back and combined in Windows Media Player.

Aux-In (Auxiliary)

Signal input to audio amplifiers to which any device with a line output can be connected.

AV input (audio/video input)

Signal input on video playback devices.

avi (AVI = Audio Video Interleave)

A video format defined by Microsoft that stores audio and video files together.

AVRCP (Audio Video Remote Control Profile)

Bluetooth profile to control audio and video devices.

➤ Bandwidth

The bandwidth is a frequency range within signal processing which is designed to transmit speech or data.

➤ cd (candela)

The “candela” unit (Latin for candle) refers to the light intensity that a light source can shine in a specific direction. A normal household candle has a light intensity of one candela.

➤ CD (Compact Disc)

An optical storage medium where data is burned onto a metal-coated plastic disc by means of a laser beam.

CD-R (Compact Disc Recordable)

CD which can be written to once only.

CD-RW (Compact Disc Rewritable)

Rewritable CD

➤ CGW (connected gateway)

Internal designation for a gateway with an integrated mobile network module required to use Audi connect vehicle-related services.

➤ CI+ module (Common Interface)

Is responsible for decrypting pay TV channels and can house an additional smartcard for additional pay TV channels.

➤ Composite video

Video transmission standard in which all signals are transmitted via a single cable.

➤ DAB (Digital Audio Broadcasting)

Digital transmission standard for the terrestrial reception of radio stations.

DAB+

An advanced version of DAB, which provides more radio stations per frequency.

➤ Data transfer rate

The data transfer rate is the amount of (digital) data which can be transferred in a specific unit of time.

DivX

A type of video compression which is used mainly to significantly compress large files at a good level of quality.

DMB (Digital Multimedia Broadcasting)

A digital transmission standard for the terrestrial reception of video and audio programmes.

DRM (Digital Rights Management)

A system to protect or be able to charge for for example, Media. One Internet example is Napster.

➤ DVB-T (Digital Video Broadcasting – Terrestrial)

Digital transmission standard for terrestrial television signals.

➤ DVB-T2 (Digital Video Broadcasting – Terrestrial 2)

Successor to DVB-T in Germany with which channels can be transmitted in HD quality.

➤ DVD (Digital Versatile Disc)

Further development of the CD with a capacity of 4.7 GB on DVDs with single layer coating (single layer DVD±R, DVD±RW) and 8.5 GB on DVDs with double layer coating (double layer; DVD±R-DL, DVD±RW-DL)

DVD±R

DVD-R and DVD+R are DVD versions that can be written to once.

DVD±RW

DVD-RW and DVD+RW are DVD versions that are rewritable.

EDGE (Enhanced Data Rates for GSM Evolution)

Extended GSM standard for data transmission. Data transfer rates up to 220 kbit/s.

exFAT (Extended File Allocation Table)

File system developed specially for flash memory.

FAT (File Allocation Table)

File system developed by Microsoft. FAT16 is used for most types of mobile data storage devices up to a size of 2 GB.

FAT32 (File Allocation Table)

File system developed by Microsoft. FAT32 is used for mobile data storage devices from 2 GB to 32 GB.

FLAC (Free Lossless Audio Codec)

Codec designed for lossless compression of data.

↗ FM (frequency modulation)

Modulation method where the base frequency is modified by the signal to be transmitted. The wavelength is within the 30 kHz to 300 kHz range.

GIF (Graphics Interchange Format)

Special graphics format for the compression of images with low color depth.

↗ GPS (Global Positioning System)

Global satellite system to determine positions and to make time measurements for the navigation system.

Gracenote

A database owned by Gracenote. The database contains information about the audio CDs available on the market (such as track, artist, genre, playing time).

↗ GSM (Global System for Mobile Communications)

An international digital mobile network standard which is used mainly for telephony but also for data transmission and text messaging.

↗ HFP (Hands Free Profile)

Bluetooth profile which allows mobile phones to be connected to the vehicle's handsfree system.

↗ HEVC or H.265 (High Efficiency Video Coding)

Standard for compressing video files. Also designated as MPEG-5. It is the successor to MPEG-4 and is used in Germany, for example, for DVB-T2 (HD video). It halves the amount of data needed compared to MPEG-4.

HSDPA (High Speed Downlink Packet Access)

Extended UMTS standard which allows data transfer rates of up to 7.2 Mbit/s.

HSDPA+

Extended version of HSDPA with possible data transfer rates of up to 42.2 Mbit/s.

HSP (Headset Profile)

Bluetooth profile which allows communication with a headset.

IMEI (International Mobile Station Equipment Identity)

The IMEI is a unique 15-digit serial number with which any GSM or UMTS device can be positively identified.

JPEG (Joint Photographic Expert Group)

Special image data format used for image data compression.

↗ LTE (Long Term Evolution)

As of 2017, the new mobile network standard. It transfers data five to six times faster than the UMTS network. Transfer rates of up to 500 Mbit/s make it possible to use infotainment functions requiring large amounts of data (for example, HD television or videoconferencing) on the move.

↗ LVDS (Low Voltage Differential Signalling)

Data transfer standard where signals are sent via two cables at a low voltage.

M3U

An open playlist file format which is used for the storage of playlists.

m4a (MPEG-4 audio)

MPEG-4 file for audio content

m4b (MPEG-4 audiobook)

MPEG-4 file for audiobooks

m4v (MPEG-4 video)

MPEG-4 file for video content

MAP (Message Access Profile)

Bluetooth profile which allows text messages and e-mails to be displayed.

↗ MIB (modular infotainment matrix)

Designation for a building block system for infotainment components used by several brands and on various models.

MMC (Multi Media Card)

Digital memory card

↗ MPEG (Moving Pictures Expert Group)

Group of experts focused on the standardization of video compression techniques.

MPEG-1/-2 Layer 3

File format for the compression of audio files with minimal loss of sound quality. The standard file ending is ".mp3".

↗ MPEG-2/-4

MPEG 2/4 formats are designed for video and audio compression and are used, among other things, for DVDs (MPEG-2) and mobile phones (MPEG-4).

MPEG-4 or H.264 (AVC)

Standard for highly efficient video compression, which can be used for a number of applications including HDTV, digicams or portable video (for example, mobile phones, iPod).

Multi SIM

Designates SIM cards which use the same contract and the same telephone number. In Germany for example, this allows up to three devices (for example, mobile phone + Audi connect + laptop) to be operated simultaneously with a single telephone number.

↗ MW (medium wave)

Electromagnetic waves, where the signal to be transmitted has the effect of changing the amplitude of the waves

(amplitude modulation). The wavelength is within the 300 kHz to 3000 kHz range.

➤ **NFC (Near Field Communication)**

Standard for wireless data transfer where the two devices communicating must be very near to each other.

NTFS (New Technology File System)

File system developed by Microsoft.

OCU (Online Connectivity Unit)

Internal Audi designation for emergency call module control unit and communication unit J949.

Ogg (also known as Ogg Vorbis)

File format for multimedia files.

➤ **OLED (organic light emitting diode)**

OLEDs emit light from organic semiconductor layers that are less than 1 µm thick.

OPP (Object Push Profile)

Bluetooth profile for sending individual files (for example, business cards or images).

PAL (Phase Alternation Line)

Standard for the analog transmission of color television. The red color difference signal of every second image line is shifted in phase through 180° relative to the preceding image line. This means that transmission errors are less visible to the observer.

PBAP (Phone Book Access Profile)

Bluetooth profile which allows the transmission of telephone and address entries.

PIN (Personal Identification Number)

A numeric code required for connecting mobile phones and thus for enabling access to the mobile phone's data. Secret multi-digit code with which a user can authenticate him/herself for a system, application or machine.

PLS (playlists)

A file format which is used for the storage of playlists.

PNG (Portable Network Graphics)

A special graphic format developed for lossless compression.

Podcast (portmanteau of "iPod" and "broadcast")

A podcast is a media file which can be downloaded from the Internet (audio or video) and also be subscribed to.

➤ **PR number**

Number with which the individual equipment on a vehicle can be identified.

RDS (Radio Data System)

Transmits additional information via the radio signal.

RSS (Rich Site Summary or Really Simple Syndication)

Format for distributing information and changes to it on the Internet.

RSS feed

Term used for RSS pages on the Internet.

➤ **SAP (SIM Access Profile)**

Bluetooth profile which directly accesses SIM card data on mobile phones. Also known as rSAP (remote SIM Access Profile).

➤ **SCON (Smart Remote Control)**

Internal Audi designation for the Rear Seat Remote.

➤ **SD (Secure Digital Memory Card)**

Secure digital memory card which can be used for for example, MP3 players, digital photos.

➤ **SDARS (Satellite Digital Audio Radio Services)**

Digital radio standard used for commercial satellite radio in North America.

SDHC (SD High Capacity)

Special SD cards which use an enhanced standard allowing storage capacities of up to 32 GB. The performance class given on the card specifies the storage speed.

➤ **SDXC (Secure Digital eXtended Capacity)**

Special SD cards which use an enhanced standard allowing storage capacities of up to 2 TB (2048 GB) and storage speeds of up to 104 MB/s.

SECAM (Séquentiel couleur à mémoire, EN: Sequential color with memory)

Analog television standard mainly used in France and eastern Europe.

➤ **SIM card (Subscriber Identity Module card)**

Chip card used to identify the user of a telephone in a network.

SMS (Short Message Service)

A service for the transmission of text messages.

➤ **SSD (Solid State Drive)**

Digital storage module which replaces the hard drives used in the past.

SSID (Service Set Identifier)

Freely selectable name for a wireless network.

TFT (Thin-Film Transistor)

Three transistors form a pixel on a TFT display.

TMC (Traffic Message Channel)

Reception of traffic data for use in dynamic navigation.

UDF (Universal Disk Format)

File system for disks.

UHV (universal preparation for mobile telephone)

Also referred to as the Audi phone box in MIB, and has PR number 9ZE.

➤ **UMTS (Universal Mobile Telecommunications System)**

Third generation mobile network standard (3G) with which higher data transfer rates of up to 384 kbit/s are possible.

UPnP (Universal Plug and Play)

The UPnP data protocol is used to activate devices in a network.

↗ USB (Universal Serial Bus)

Universal serial interface for the exchange of data between a computer and a device.

↗ Valet parking

Parking services offered at public car parks. These include, for example, parking and returning the vehicle. Other services such as washing and vacuuming the vehicle may also be included.

vCard (electronic business card)

File format used for the direct transfer of address cards to an e-mail program. The usual file ending is ".vcf".

VIN (Vehicle Identification Number)

Vehicle identification number (17-character) consisting of letters and numbers. Also referred to as the chassis number.

WAVE

Compression standard for the digital storage of audio files.

Wearables

Wearable computer systems secured to the user's body during use, such as intelligent wristbands, special clothes with additional functions, smartwatches and data glasses.

↗ Wi-Fi (WLAN, Wireless Local Area Network)

Wireless local network

wma (Windows Media Audio)

Special audio format for Microsoft Windows.

wmv (Windows Media Video)

Video file compression standard developed by Microsoft. Typical file endings are ".asf" and ".wmv".

WPL (Windows Media Player Playlist)

Audio file playlists for Windows Media Player.

Xvid

A free method of compressing video files based on the MPEG-4 format.

↗ zFAS

Internal Audi designation for Driver Assistance Systems Control Module J1121.

eSelf-study programs

For further technical information on the Audi A8 , please refer to the following eSelf-Study programs.

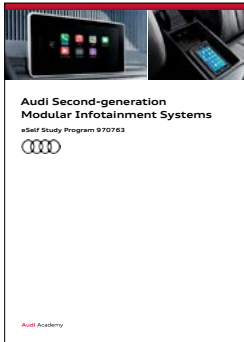

[SSP 970763](#)
[Audi Second-generation](#)
[Modular Infotainment System](#)

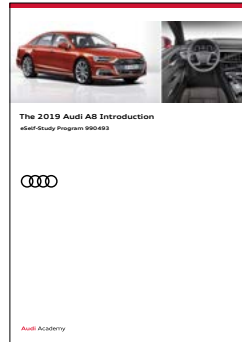

[SSP 990493](#)
[The 2019 Audi A8 Introduction](#)

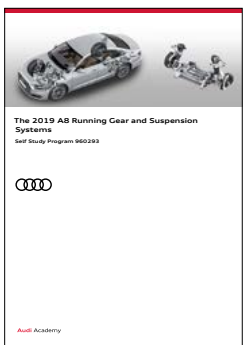

[SSP 960293](#)
[The 2018 Audi A8](#)
[Running Gear and Suspension Systems](#)

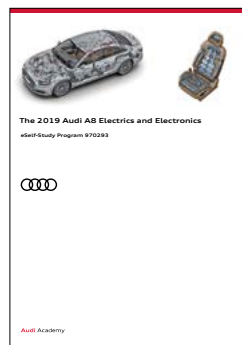

[SSP 970293](#)
[The 2019 Audi A8](#)
[Electrics and Electronics](#)

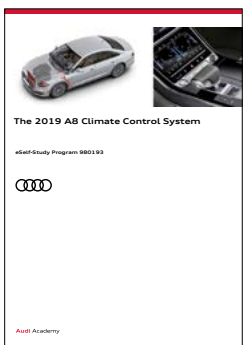

[SSP 980193](#)
[The 2019 Audi A8](#)
[Climate Control Systems](#)

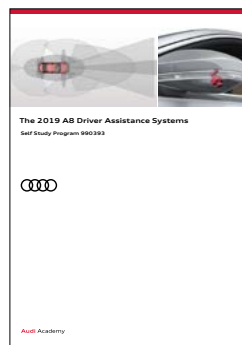

[SSP 990393](#)
[The 2019 Audi A8 Driver Assistance](#)
[Systems](#)

Knowledge assessment

An On-Line Knowledge Assessment (exam) is Available for this eSelf-Study Program.

The Knowledge Assessment is required for Certification credit.

You can find this Knowledge Assessment at: www.accessaudi.com

From the accessaudi.com Homepage:

- › Click on the “App Links”
- › Click on the “Academy site CRC”

Click on the Course Catalog Search and select “990293 - The 2018 Audi A8 Infotainment and Audi Connect Systems”

Please submit any questions or inquiries via the Academy CRC Online Support Form which is located under the “Support” tab or the “Contact Us” tab of the Academy CRC.

Thank you for reading this eSelf-Study Program and taking the assessment.

All rights reserved.
Technical specifications subject to
change without notice.

Audi of America, LLC
2200 Ferdinand Porsche Drive
Herndon, VA 20171